

# GOLDEN<sup>®</sup>

BOAT LIFTS & MARINE SYSTEMS

---

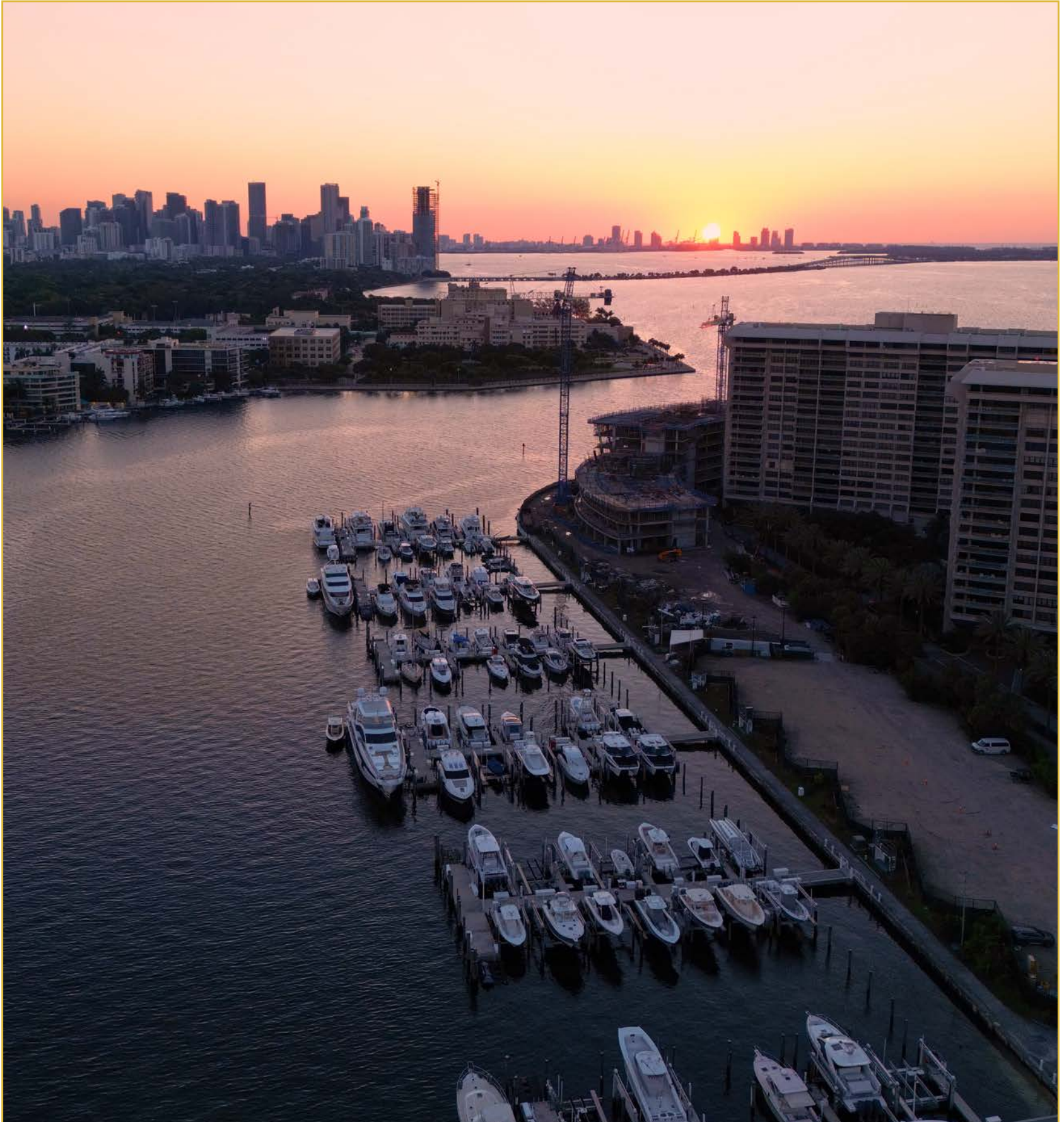











# CONTENTS

## FEATURES

**6**  
The Gold Standard

**8**  
4-Post Boat Lifts

**14**  
8-Post Boat Lifts

**20**  
Freestanding Lifts

**22**  
GatorVator® Lifts

**28**  
3K Single Track Elevators

**30**  
Elevators

**36**  
Invisilifts™

**38**  
Float-A-Vator™ Lifts

**40**  
Tornado® Boat Lifts

**44**  
Golden Boat House Lifts

**46**  
Sailboat Lifts



**36**



**22**



**8**



**46**



# CONTENTS

## FEATURES

52



64

58



78

52

Floating Dock Lifts

54

Deck Lifts

58

PWC Lifts

62

Kayak Launch®

64

The Golden Sea-Drive®

66

The Competitive Advantage

68

Government Municipalities

76

Accessories

78

Golden Marine Systems

122

Golden SunShade™

124

TikiMundo



# THE GOLD STANDARD



Golden Boat Lifts® has a rich history of over 35 years of innovation and excellence in the marine industry. Founded by Bill Golden with a vision to revolutionize the way boats are lifted and stored, we have consistently set the benchmark for quality and reliability. Golden's journey began with a commitment to superior craftsmanship and the use of the highest-grade materials, ensuring our products stand the test of time. Over the years, we have expanded our offerings to include a wide range of customizable solutions, each designed to meet the unique needs of our customers. From Golden's patented Sea-Drive® to the cutting-edge InvisiLift™, we continue to lead the industry with groundbreaking products. At Golden Boat Lifts®, we pride ourselves on providing unparalleled service and support, making us the trusted choice for boat owners worldwide. Our legacy is built on a foundation of innovation, dedication, and a passion for excellence.







**BILL GOLDEN**

Bill Golden, the visionary founder and CEO of Golden Boat Lifts®, has dedicated his career to advancing the marine industry through trailblazing inventions and superior quality. With a passion for boating and a keen eye for engineering, Bill established Golden Boat Lifts® with the goal of creating superior, reliable lifting solutions for boat owners. His leadership and commitment to excellence have propelled the company to the forefront of the industry, earning a reputation for unmatched craftsmanship and customer satisfaction. Bill's entrepreneurial spirit and dedication to continuous improvement have driven the development of groundbreaking products, including over twelve patents. Under his guidance, Golden Boat Lifts® has grown into a global leader, setting new standards for quality and innovation in marine lifting systems.





# 4-POST BOAT LIFT

ULTIMATE 4-POST BOAT LIFT  
SUPERIOR CRAFTSMANSHIP







Golden's incredible 4-Post Boat Lifts stand out in the industry for their unrivaled durability and exceptional performance. Engineered with precision, these lifts provide robust support for your boat, ensuring safe and reliable operation for years to come. Featuring high-grade 300 series stainless steel hardware and cables, our 4-Post lifts are designed to withstand the harshest marine environments, offering superior corrosion resistance. With a focus on both functionality and longevity, Golden's 4-Post Boat Lifts are the ultimate solution for boat owners seeking the best in quality and dependability.

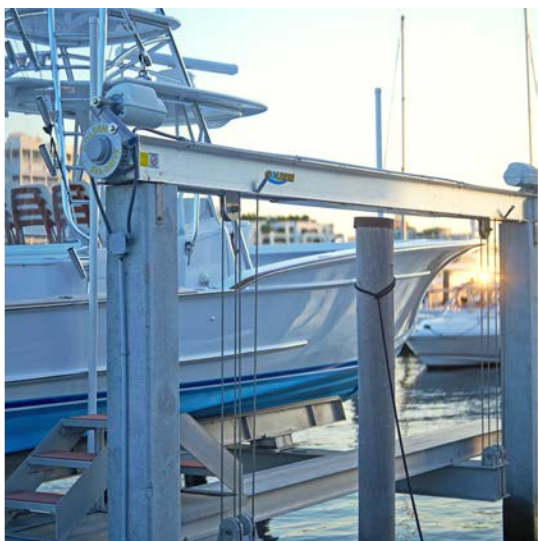
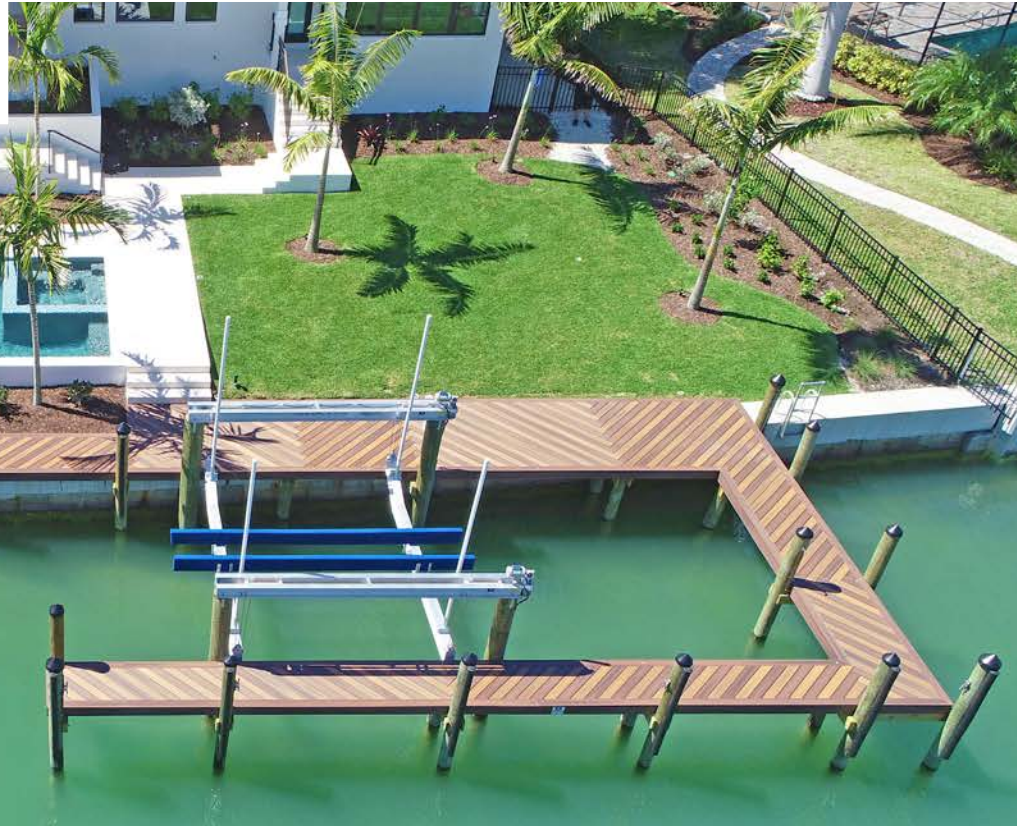





# 4-POST BOAT LIFT







# CAPACITIES

5,000 lbs.	14,000 lbs.	30,000 lbs.
7,500 lbs.	16,000 lbs.	32,000 lbs.
10,000 lbs.	20,000 lbs.	40,000 lbs.
12,000 lbs.	24,000 lbs.	56,000 lbs.
	28,000 lbs.	



# FEATURES

- 6061-T6 marine grade aluminum
- 300 series stainless steel hardware
- Fully welded aluminum structure on all non-adjustable parts
- Top beams with bearing blocks & patented anti-shear plates
- 3.5" grooved aluminum winders with patented cable retention bolt
- 10-year warranty on Golden Sea-Drives®
- Stainless steel motors & cables
- Golden has been certified by DQS Inc. to ISO 9001:2015 (see Pages 26-27 to learn more about our ISO certification)





# UNLOCKING EFFICIENCY: THE DOMINANCE OF GOLDEN'S 4-POST BOAT LIFTS

In the realm of boating, convenience, reliability, and efficiency are paramount. When it comes to safely storing and maintaining your boat, the choice of a boat lift can significantly impact your boating experience. Among the various options available, one type stands out as the undisputed leader: the Golden 4-Post Boat Lift. Let's delve into why these lifts reign supreme in the marine industry.





## 1. Unrivaled Stability

Boats come in all shapes and sizes, from sleek speedboats to sturdy pontoons. The beauty of 4-Post Boat Lifts lies in their ability to provide unparalleled stability and support for boats of any size. With four sturdy posts supporting the weight of the boat evenly, owners can rest assured that their prized possession is securely cradled above the water, minimizing the risk of damage caused by shifting or uneven weight distribution.

## 2. Versatility

Just as boats vary in size and shape, so do boat lifts. However, 4-Post Boat Lifts shine in terms of versatility. Whether you own a fishing boat, a pontoon, a sailboat, or a personal watercraft, a 4-Post Boat Lift can accommodate your vessel with ease. With adjustable bunks and customizable configurations, 4-Post Boat Lifts offer the flexibility needed to lift and support a wide range of boat types, making them a popular choice among boat owners with diverse needs.

## 3. Ease of Use

Gone are the days of struggling to hoist your boat out of the water with manual labor. Our 4-Post Boat Lifts are designed with user convenience in mind. With simple push-button operation or remote-control functionality, raising and lowering your boat becomes effortless and hassle-free. This ease of use not only saves time but also reduces the risk of accidents or injuries associated with manual lifting methods, allowing boat owners to focus on enjoying their time on the water.

## 4. Durability and Longevity

Investing in quality equipment is essential for any boat owner, and 4-Post Boat Lifts deliver on durability and longevity. Constructed from marine-grade materials such as aluminum, these lifts are built to withstand the harsh marine environment, including exposure to saltwater, UV rays, and fluctuating weather conditions. With proper maintenance and care, a 4-Post Boat Lift can provide years of reliable service, giving boat owners peace of mind knowing their investment is protected.

## 5. Space Optimization

In addition to lifting and storing boats, 4-Post Boat Lifts offer valuable space optimization solutions. By raising the boat out of the water, owners can reclaim valuable dock space for other activities such as swimming, fishing, or entertaining. This efficient use of space not only enhances the functionality of the dock but also improves overall safety by reducing clutter and congestion around the water's edge.



Our 4-Post Boat Lifts stand out as the most efficient and sought-after choice for boat owners due to their unrivaled stability, versatility, ease of use, durability, and space optimization capabilities. Whether you own a small fishing boat or a cabin cruiser, a 4-Post Boat Lift provides the peace of mind and convenience you need to fully enjoy your time on the water. Rest assured your boat will be safe in our hands with capacities ranging from 5,000 lbs all the way up to 240,000 lbs! See why we are your global leader and contact us today.

# 4-POST BOAT LIFT



# 8-POST BOAT LIFT

8-POST BOAT LIFT:  
INCOMPARABLE STRENGTH & STABILITY







Golden's unmatched 8-Post Boat Lifts redefine strength and stability in the marine industry. These lifts are engineered to provide maximum support for larger boats, ensuring secure and sustainable lifting capabilities. Built with high-grade 300 series stainless steel hardware and cables, our 8-Post Boat Lifts offer superior corrosion resistance and protection, even in the severe saltwater marine conditions. Designed for boat owners who demand the best, Golden's 8-Post Boat Lifts deliver unparalleled performance, durability and dependability, making them the top choice for those seeking optimum quality and reliability.







# 8-POST BOAT LIFT

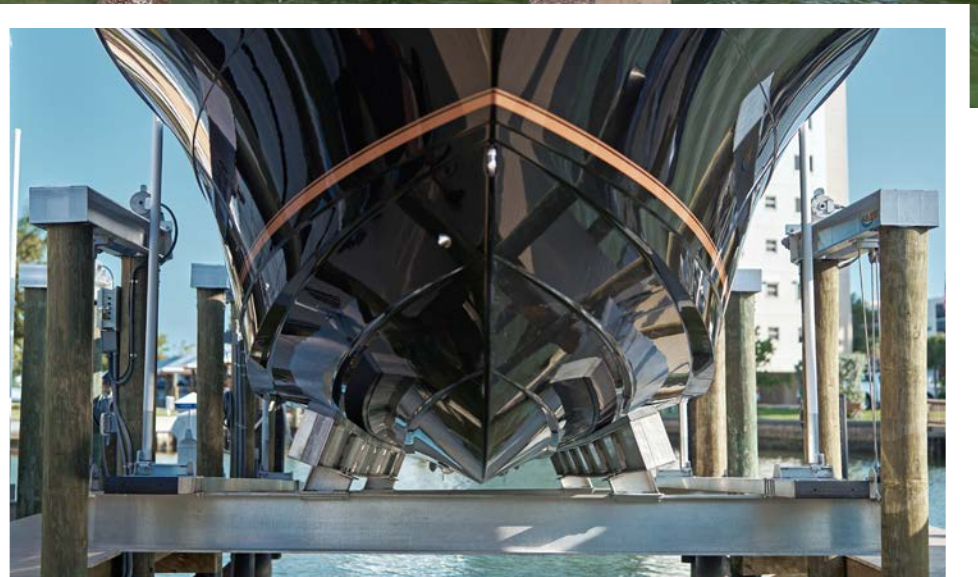



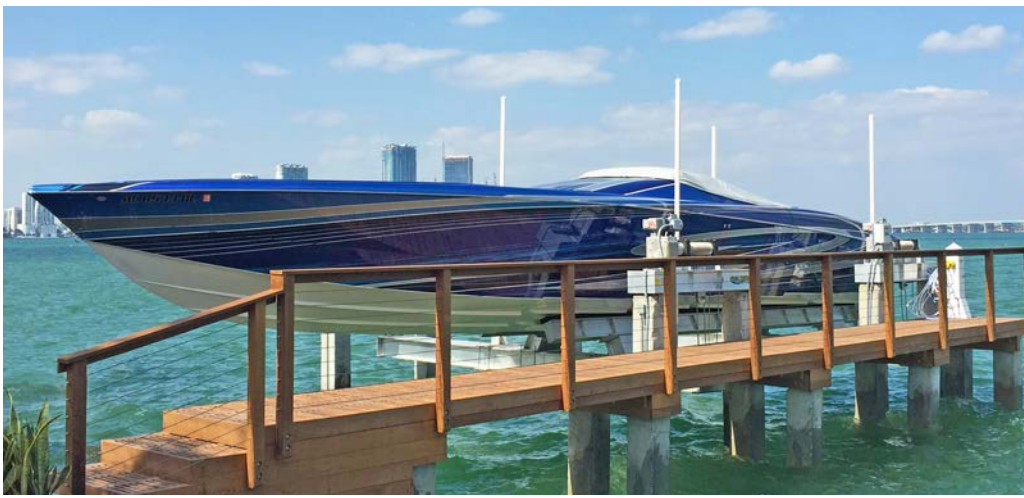

## CAPACITIES

32,000 lbs.	60,000 lbs.	160,000 lbs.
40,000 lbs.	80,000 lbs.	180,000 lbs.
56,000 lbs.	120,000 lbs.	240,000 lbs.

\*Larger capacities available upon request



## FEATURES

- 6061-T6 marine grade aluminum
- 300 series stainless steel hardware
- Fully welded aluminum structure on all non-adjustable parts
- Top beams with bearing blocks & patented anti-shear plates
- 3.5"-6" grooved aluminum winders with patented cable retention bolt
- Aluminum I-beam bunks
- Golden Sea-Drives® that come with a 10-year warranty
- Stainless steel motors & cables
- Goliath Grove gears and brakes on 60,000 lb. lifts and up
- Golden has been certified by DQS Inc. to ISO 9001:2015 (see Pages 26-27 to learn more about our ISO certification)





# WHAT TO KNOW WHEN BUYING A BOAT LIFT:

Investing in a boat lift is a crucial decision that boat owners have to make, ensuring that it meets the safety requirements, convenience and longevity of their boat. Due to the numerous options available on the market, it can be confusing to choose which boat lift is the right one for you, therefore it is important to understand the various details related to boat lifts. Here's a comprehensive guide on what to know when buying a boat lift.





## Understanding Your Requirements

The first step for choosing the right boat lift is to understand your specific needs and requirements. Consider the size and weight of your boat, the water conditions under which you'll be using the boat lift and the space available for installation. Golden Boat Lifts® offers a diverse range of boat lifts such as Elevator Lifts, 4-Post & 8-Post Lifts, PWC Lifts, Floating Lifts, Deck Lifts, Tornado® Lifts, Freestanding Lifts and many more. These lifts are designed to accommodate different boat sizes and water conditions. Our expert team can assist you in selecting the perfect boat lift that meets your needs and requirements.

## Quality and Durability

It is crucial to invest in a high quality and durable boat lift so it lasts for a long time. Golden Boat Lifts® ensures the finest materials, such as marine-grade aluminum and stainless steel. These materials are recognized for their durability, strength and resistance to corrosion, making them perfect materials for boat lift construction.

- **Marine-Grade Aluminum:** It is known for its lightweight yet robust properties and resistance to corrosion. These properties ensure your boat lift remains in optimal condition even in harsh marine environments. Its lightweight nature also facilitates easier installation and maintenance.
- **Stainless Steel:** It is known for its strength and resilience. Stainless steel offers excellent resistance to rust, corrosion and damage, providing long-lasting protection against severe marine conditions.
- **Patented Features:** Golden holds the most patents on features enabling safety and durability.

## Efficiency and Convenience

With innovative designs focused on user-friendliness and functionality, Golden Boat Lifts® offer smooth lifting operations, intuitive controls and easy installation. An efficient boat lift streamlines the process of launching and storing your boat, making it convenient for you.

## Safety and Warranty

Safety is of utmost importance when it comes to boat lifts. A good boat lift has advanced safety features such as automatic locking mechanisms, overload protection and weather-resistant components.

Warranties and customer support are important to consider when choosing a boat lift. Prompt assistance and guidance for installation, maintenance or troubleshooting make your boat lift ownership worry-free. At Golden, we offer the longest warranties in the industry, over five years longer than our nearest competitor!



Golden Boat Lifts® can be your perfect partner as we offer customizable boat lifts tailored according to your exact specifications. With Golden Boat Lifts®, you're making a smart investment in your boating lifestyle, ensuring a seamless and enjoyable boating experience on the water.



# FREESTANDING BOAT LIFT

PREMIER FREESTANDING BOAT LIFT:  
VERSATILE & RELIABLE





Discover the best of both worlds: the dependable stability of a post lift combined with the unmatched versatility of a bottom-based lift. Our innovative Freestanding Lift features a robust framework for exceptional stability and four individually adjustable legs for precise leveling. This lift is perfect for areas where permanent boat lifts or pilings are impractical, and it can easily be removed during winter months. It is another incredible option for shallower waters.

Say goodbye to expensive power requirements! Our lifts are available with optional stainless steel waterproof 24-volt DC motors and solar or trickle chargers, ensuring you're always ready for a boating adventure.

Plus, enjoy the convenience of bypassing the permitting process as the Freestanding Lift is classified as temporary in most cases. Check with your municipality for more details.

Enhance your waterfront experience with this prime lifting solution.

### Key Features:

- Adjustable leg height
- Cable lock block
- Multiple bunk options
- Anti-shear cable return plate
- 3.5" cable winder
- Field adjustable footprint
- Available with slings for very shallow water
- Golden has been certified by DQS Inc. to ISO 9001:2015 (see Pages 26-27 to learn more about our ISO certification)

## CAPACITIES

### 2 MOTOR

5,000 lbs.  
7,500 lbs.  
10,000 lbs.  
12,000 lbs.  
14,000 lbs.  
16,000 lbs.  
20,000 lbs.  
24,000 lbs.

### 4 MOTOR

30,000 lbs.  
32,000 lbs.  
40,000 lbs.  
56,000 lbs.





# GATORVATOR<sup>®</sup>

## BOAT LIFT

PATENT #: 6,918,345; 6,470,816

### THE PATENTED GATORVATOR<sup>®</sup>: LIFTING REDEFINED







Golden's patented Gatorvator® represents the pinnacle of innovation in boat lifting technology. Designed to deliver unmatched performance and ease of use, the Gatorvator® combines cutting-edge engineering with durable construction to provide a seamless and reliable lifting experience. Featuring our proprietary design, this lift ensures optimal stability and safety for your vessel, all while being user-friendly. Built with high-quality materials and designed to withstand the toughest marine conditions, the Gatorvator® is the perfect solution for boat owners seeking efficiency as well as visibility. Trust Golden Boat Lifts® to bring you the best in boat lifting technology with the revolutionary Gatorvator®.







# GATORVATOR<sup>®</sup>

## BOAT LIFT

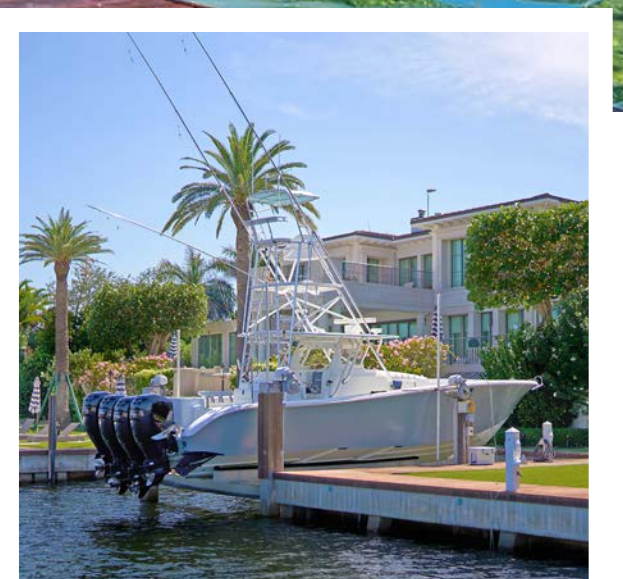



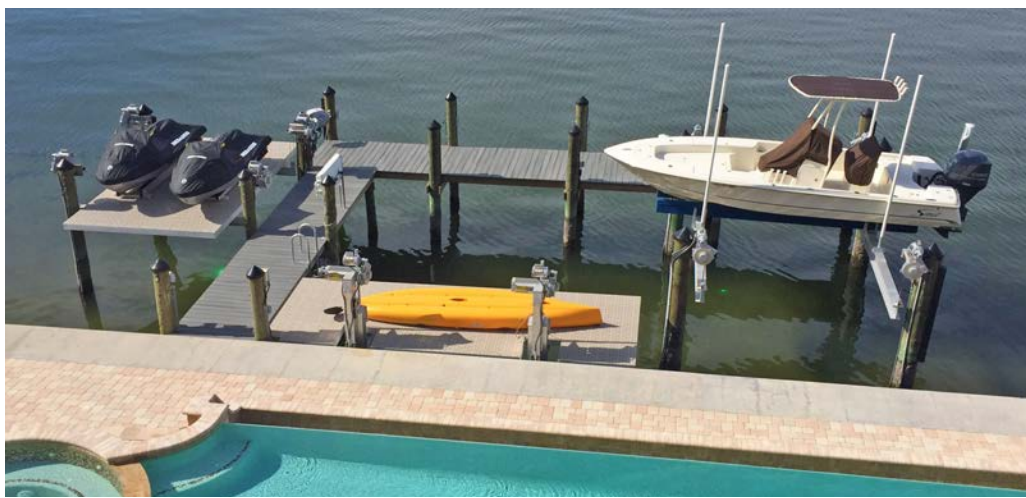

## CAPACITIES

4,000 lbs.	14,000 lbs.	24,000 lbs.
7,000 lbs.	16,000 lbs.	30,000 lbs.
10,000 lbs.	20,000 lbs.	



## FEATURES

- Ease of maintenance.
- The GatorVator® lift requires 2-4 drive spools. They are 3" diameter and grooved for the longest cable life possible; the cables never wrap over the top of each other.
- Fits in narrow areas along the dock.
- Fits most pile configurations.
- Lifting speed up to 33% faster.
- 15-year structural warranty, 10-year on the Golden Sea-Drive®, 2-year on all other parts.
- This clean look is adaptable to boat houses, existing pilings, and other structures.
- This design has eliminated the common objections of the top beam of a lift being unsightly and boarding a difficulty.
- Golden has been certified by DQS Inc. to ISO 9001:2015 (see Pages 26-27 to learn more about our ISO certification)

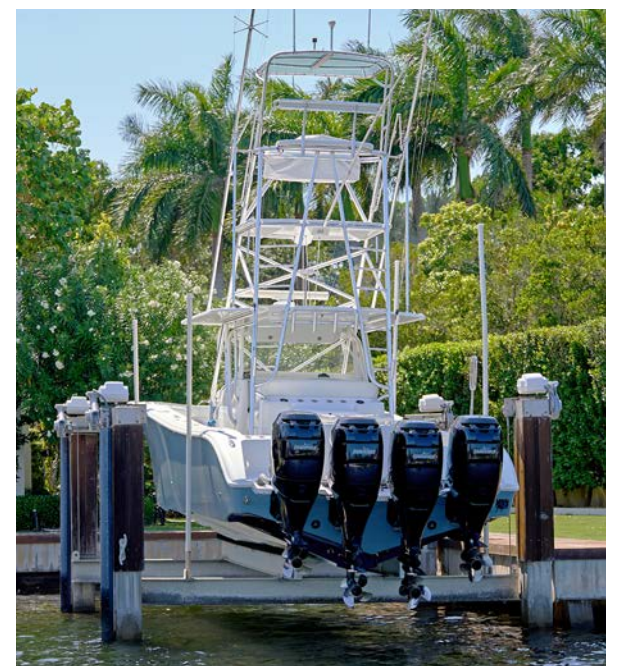



# GOLDEN MANUFACTURING HAS BEEN CERTIFIED BY DQS INC. TO ISO 9001:2015

---



## What does ISO mean?

ISO 9001 (latest revision is 2015) is an international standard for a company's quality management system. A company that is ISO certified has met a set of requirements for quality, process improvement and maximum customer satisfaction. It is a way to show your customers that the company is very serious about quality.

## Why did we do it?

In 2012, Bill Golden decided he wanted his company to be the first boat lift company to achieve ISO certification. Bill also recognized two main benefits:

**External:** Bill wanted all of his customers, as well as the marine industry, to know how much he values them. By achieving this certification, Golden Manufacturing instantly became a trusted company that is always striving to improve all areas of the business for its customers. In addition, all potential customers know that when you deal with Golden, you'll be getting a high-quality boat lift with the backing of the entire company.

**Internal:** Golden has improved tremendously over the years with the development and structure of internal policies, procedures, SOP's and work instructions. Nearly every process is formalized for a consistent and high-level approach to building high quality boat lifts. These processes include quality planning, inspections, control of non-conforming products, and continuous improvement among many others.





## How did we do it?

We took an honest look at where the business was and where we had to go to achieve certification. A plan was put in place to maintain a schedule while satisfying all of the requirements of the standard. Once the plan was in place, we wrote procedures, implemented required processes, and trained employees. We were certified in 2013.

## Why is this important to you, our customer?

It's one thing to get certified but it's another to maintain the certification. Every year, an independent third-party auditor comes on site to verify that we're still maintaining our high level of excellence and service. Every year, the auditor looks to see if we're improving in our processes and procedures. As long as we continue to maintain our certification, you'll have a high level of confidence in Golden Boat Lifts.

All these years later, we still feel we made the right decision to pursue ISO 9001:2015 certification. Golden's track record more than speaks for itself. We have sold tens of thousands of boat lifts and our quality is world class.

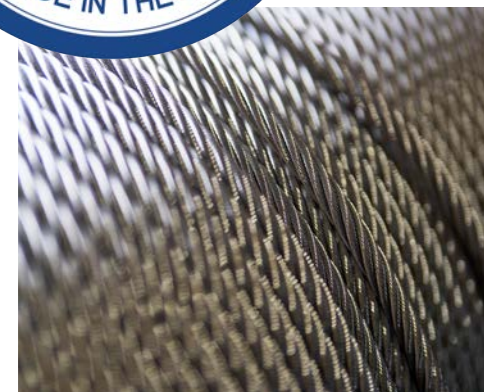



# 3K SINGLE TRACK ELEVATOR

3K SINGLE TRACK ELEVATOR LIFT:  
A SUPERIOR SOLUTION FOR SMALLER VESSELS







Golden's 3K Single Track Elevator Lift is designed to offer unparalleled convenience and safety for boating enthusiasts. This state-of-the-art lift system boasts a 3,000-pound capacity, ensuring it can effortlessly handle a wide range of smaller vessels. Its single-track design allows for smooth and efficient lifting, making boat maintenance and storage more accessible than ever. With its durable construction and advanced features, the 3K Single Track Elevator Lift stands as a testament to Golden Boat Lifts® commitment to quality and innovation in marine technology. Whether for personal use or commercial applications, this lift provides a reliable and efficient solution to elevate your boating expeditions.





# ELEVATOR BOAT LIFT

EXQUISITELY DESIGNED ELEVATOR:  
EXPERIENCE STYLE & EFFICIENCY







Our exquisitely designed elevator combines elegance and functionality, offering a harmonious blend of luxury and practicality. Crafted with meticulous attention to detail, this elevator features advanced technology and sophisticated aesthetics to enhance any space. With customizable options and modern safety features, our elevator provides a personalized and secure dwelling for your vessel, bringing your lifestyle to new heights. Discover the perfect balance of style and efficiency with our industry leading elevator.







# ELEVATOR BOAT LIFT







# CAPACITIES

3,000 lbs.	12,000 lbs.	26,000 lbs.
5,000 lbs.	15,000 lbs.	30,000 lbs.
7,000 lbs.	17,000 lbs.	40,000 lbs.
10,000 lbs.	20,000 lbs.	60,000 lbs.
	24,000 lbs.	

\*Larger sizes available upon request



# FEATURES

- Patented Golden Sea-Drive® with 10-year warranty
- Stainless steel cables and motors
- Sacrificial zinc anodes
- 3.5" solid aluminum grooved winders
- Solid aluminum billet bearing blocks
- Lexan winder covers and elevator head corner bumpers
- Fully welded aluminum structure on all non-adjustable parts
- 6061-T6 marine grade aluminum
- 300 series stainless steel hardware
- Heavy duty UV rated Nylatron wheels
- Stainless steel equalizer brackets
- Golden has been certified by DQS Inc. to ISO 9001:2015 (see Pages 26-27 to learn more about our ISO certification)





# HOW LONG DOES IT TAKE FROM ORDERING TO INSTALLATION OF A BOAT LIFT?

Choosing the right boat lift can be a challenging task, with so many options available on the market. However, the convenience this investment offers is unlimited, it will make it easier for you to get your boat in and out of the water as well as help prevent corrosion and water damage caused by harsh marine environments.

Placing an order for a boat lift and getting it installed is an exciting experience for any boat owner. To plan for the lift installation properly, it's crucial to understand the time duration from order placement to installation. Understanding this timeline helps in ensuring a smooth process.

Let's explore the general process and usual timeline involved in getting a boat lift installed.





## Placing the Order

The exciting journey starts with you placing an order, you will have to select the kind of boat lift that will best suit your needs. Golden Boat Lifts® understands that boat owners have diverse needs, which is why we provide a variety of options such as Elevator Lifts, 4-Post & 8-Post Lifts, Floating Dock Lifts, Tornado® Lifts, Boat Houses, Deck Lifts, Golden Float Lifts™, PWC lifts, our patented GatorVator® lifts, our newest Invisilift™ and even custom-designed boat lifts.

## Initial Consultation & Site Assessment

After placing your order, our marine contractor in your area typically conducts a site assessment. Their skilled and professional team will visit the site to assess the specific conditions such as how deep the water is, dock configuration and accessibility to the installation site.

This evaluation helps ensure that the lift that you have ordered for your dock and boat is suitable considering the location. The time taken for a company representative to assess the site can be anywhere between a few days to a couple of weeks, depending on availability.

## Design & Customization

If you have chosen to order a custom-made lift the design process will take place after the site assessment. During this phase, detailed engineering plans are made according to your specific needs.

If you choose to go for a pre-existing boat lift model this phase can be completed faster, but for custom-made lifts, the time taken will be longer. The usual time duration for this phase is between one to three weeks, depending on how complex the design is.

## Manufacturing

After the design is finalized, the manufacturing process begins. The time taken for manufacturing varies. For smaller capacity vessels, it takes between one to six weeks to build. For larger vessels, it can take up to 12 weeks to build.

## Shipping

Once the manufacturing process is completed, the lift is shipped either to your location or your installer's location. The shipping times can vary depending on the distance from the manufacturing facility to your location. Typically, domestic shipping within the United States takes anywhere between a few days to half a month but for international orders, the shipping time can be much longer due to customs and increased distance.

## Installation

The installation process includes assembling the lift, securing it to the dock and checking that all the mechanical and electrical systems function seamlessly. Installing simpler models like single-post lifts or small lifts takes from a few hours to a few days. Complex models such as multi-post lifts or custom-designed lifts take longer to install.

## Other Factors Influencing the Timeline

Some factors influencing the timeline include seasonal demand, customizations, complex site conditions and obtaining permits. During peak boating seasons demand for boat lifts may increase, which could lead to longer wait times.

The overall time duration involved in ordering a boat lift and getting it installed can take from one week to 6 months. However, this timeline can vary based on the circumstances mentioned above and so it's necessary to plan ahead of time and contact a certified marine contractor to help you get your boat lift installed.

For ordering and installing 4-Post Boat Lifts, Elevator Boat Lifts, Floating Lifts, Deck Lifts, custom-made boat lifts, or any other of our remarkable boat lifts, contact Golden Boat Lifts®. We will be your strategic partner ensuring our high-quality lifts make your boating adventures enjoyable ones.



# INVISILIFT™

## BOAT LIFT

BLEND IN WITH THE SCENERY  
WITH OUR PATENTED INVISILIFT™





# CAPACITIES

3,500 lbs.      10,000 lbs.  
7,500 lbs.      15,000 lbs.

Explore the pinnacle of innovation and craftsmanship with the Invisilift™ by Golden Boat Lifts®. Designed to blend seamlessly with its surroundings while offering unmatched performance, the Invisilift™ sets a new standard in boat lifting technology. Whether you're a boating enthusiast or a marina operator, the Invisilift™ promises reliability, ease of use, and an elegant solution for all your boat lifting needs.



## Key Features:

- **Sleek, Low-Profile Design:** The Invisilift™ is designed to be virtually invisible, preserving the natural beauty of your waterfront.
- **Superior Lifting Capacity:** Capable of lifting a wide range of vessels with ease, the Invisilift™ ensures your boat is securely elevated out of the water.
- **Durability and Strength:** Constructed with marine-grade materials, the Invisilift™ is built to withstand harsh marine environments, ensuring longevity and peace of mind.
- **User-Friendly Operation:** With its intuitive control system, operating the Invisilift™ is simple and straightforward, allowing you to effortlessly lift and lower your boat.
- Golden has been certified by DQS Inc. to ISO 9001:2015 (see Pages 26-27 to learn more about our ISO certification)

## Benefits:

- **Enhanced Aesthetics:** Maintain the pristine look of your dock or marina with Invisilift's™ unobtrusive design.
- **Increased Boat Longevity:** By lifting your boat out of the water, the Invisilift™ helps prevent hull damage, marine growth, and corrosion, extending the life of your vessel.
- **Efficient Space Utilization:** Optimize your dock space with the Invisilift's™ compact design, making it ideal for narrow canals or private docks.



# FLOAT-A-VATOR™

## BOAT LIFT

THE FLOAT-A-VATOR™:  
EFFORTLESS LIFTING, UNMATCHED PERFORMANCE







The Float-A-Vator™ Boat Lift is built to last with a marine-grade aluminum and stainless steel frame, 300 series stainless hardware, and UV-resistant polyethylene tanks. This versatile lift can be secured to a floating dock or installed using a conventional mooring system.

Standard features include a trouble-free, maintenance-free manual controller, with the option to upgrade to a self-leveling electronic controller. Designed to accommodate nearly all boat types, the Float-A-Vator™ is perfect for V-hull, catamaran, wake boat, pontoon, tritoon, and jet drive boats. Compatible with both fixed and floating docks, this lift works seamlessly in U-shaped slips, double-wide slips, and L-shaped docks.



## CAPACITIES

3,000 lbs.	12,000 lbs.	25,000 lbs.
7,500 lbs.	16,000 lbs.	32,000 lbs.
9,000 lbs.	20,000 lbs.	35,000 lbs.

\*Golden has been certified by DQS Inc. to ISO 9001:2015  
(see Pages 26-27 to learn more about our ISO certification)



# TORNADO<sup>®</sup>

## BOAT LIFT

TORNADO<sup>®</sup> LIFTS:  
POWER & PRECISION FOR SUPERIOR BOAT CARE







Experience the unbeatable power and precision of Tornado® Lifts by Golden Boat Lifts®. Engineered for superior performance, our Tornado® Lifts are designed to provide effortless and secure lifting for boats of various sizes and weights. With a focus on durability, reliability, and ease of use, the Tornado® Lift stands out as a premier choice for both residential and commercial marine applications.







# TORNADO<sup>®</sup> BOAT LIFT





## Tornado® Key Features:

- Superior Craftsmanship: Built with marine-grade aluminum and stainless steel components, the Tornado® Lift ensures long-lasting durability even in the harshest marine environments.
- High-Capacity Lifting: Equipped to handle numerous vessels, the Tornado® Lift offers impressive lifting capacities, making it ideal for heavy-duty applications.
- Advanced Control Systems: Featuring state-of-the-art control systems, including optional remote controls, the Tornado® Lift allows for smooth and precise operation with minimal effort.
- Safety and Stability: Designed with reinforced structures and safety mechanisms, the Tornado® Lift guarantees stable and secure lifting, providing peace of mind for boat owners.
- Versatile Applications: Compatible with a wide range of dock configurations and boat types, the Tornado® Lift offers flexible installation options to suit your specific needs.
- 4, 5, and 6 foot lifting ranges.
- Golden has been certified by DQS Inc. to ISO 9001:2015 (see Pages 26-27 to learn more about our ISO certification)



## Why Choose Tornado® Lifts?

Golden Boat Lifts® is renowned for its commitment to quality and innovation. The Tornado® Lift exemplifies this dedication by offering a product that not only meets but exceeds industry standards. Whether you're looking to protect your investment or enhance your boating experience, the Tornado® Lift provides the power and precision needed to ensure your boat is safely and securely lifted every time.

## Experience the Golden Difference with Tornado® Lifts:

Upgrade your boat lifting capabilities with the unparalleled strength and reliability of the Tornado® Lift by Golden Boat Lifts®. Trust in our expertise and commitment to quality to provide you with a lifting solution that stands the test of time.

## CAPACITIES

2,000 lbs.	8,000 lbs.	15,000 lbs.
4,500 lbs.	10,000 lbs.	18,000 lbs.
6,000 lbs.	12,000 lbs.	24,000 lbs.

\*Larger capacities available upon request



# BOAT HOUSE

## LIFT

LUXURY, SECURITY & CONVENIENCE  
FOR YOUR WATERFRONT LIFESTYLE







Discover the luxury, security, and convenience with the Golden Boat House Lift. Designed to provide a premium storage solution for your boat, the Golden Boat House Lift offers unparalleled protection from the elements, ensuring your vessel remains in pristine condition year-round. Its elegant and superior construction smoothly integrates with your waterfront property, adding both aesthetic appeal and functional value. With customizable options to suit your specific needs, the Golden Boat House Lift enhances your boating lifestyle by offering easy access, premium security features, and the peace of mind that comes from knowing your boat is well-protected. Experience the Golden difference and increase your waterfront living with the Golden Boat House Lift.



\*Golden has been certified by DQS Inc. to ISO 9001:2015  
(see Pages 26-27 to learn more about our ISO certification)



# SAILBOAT LIFT

PRECISION LIFTING  
FOR YOUR SAILING NEEDS







Golden Sailboat Lifts are meticulously engineered to meet the unique needs of sailboat owners, offering smooth and streaming lifting solutions. Our lifts are constructed from premium marine-grade materials, ensuring durability and longevity even in the most brutal marine environments. Designed for precision and stability, Golden Sailboat Lifts provide confidence by safely lifting and storing your sailboat, protecting it from damage and other elements. Whether you have a compact daysailer or a large cruising yacht, our customizable lifts accommodate various sizes and configurations, making launching and retrieving your sailboat a breeze. Enhance your sailing lifestyle with the reliability and convenience of Golden Sailboat Lifts, and trust us to keep your sailboat in pristine condition.

All of our exquisite sailboat lifts are customized and can be manufactured in all capacities.

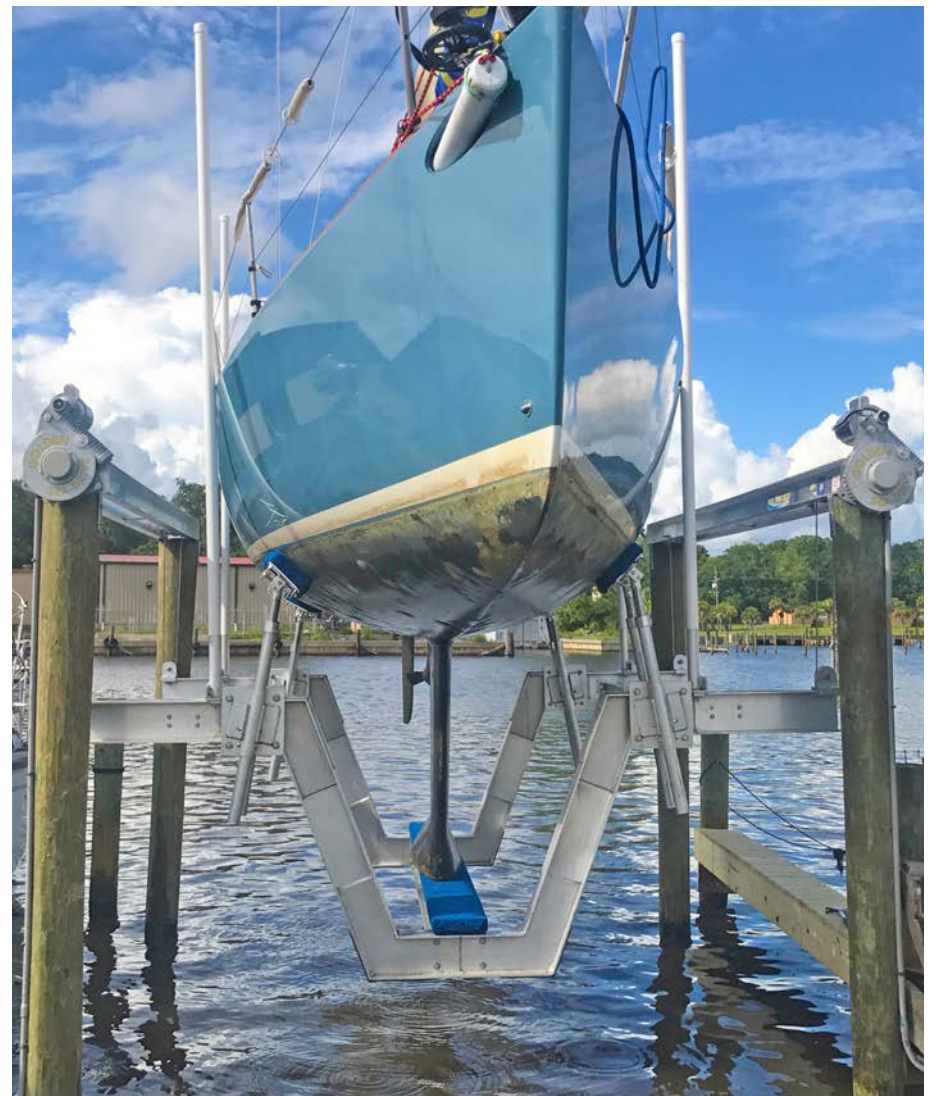

\*Golden has been certified by DQS Inc. to ISO 9001:2015  
(see Pages 26-27 to learn more about our ISO certification)



# SAILBOAT LIFT

Golden Boat Lifts® sailboat lifts are renowned for their exceptional quality and complete customization. Each lift is meticulously crafted to meet the unique specifications and requirements of the sailboat it is designed to support. The customization process ensures that every component, from the cradles and bunk systems to the lifting mechanisms, is tailored to fit the boat's dimensions and weight distribution precisely. This bespoke approach not only guarantees a secure and stable lift for the sailboat but also enhances the overall durability and performance of the lift. By providing 100% customized solutions, Golden Boat Lifts® ensures that each sailboat lift offers optimal protection and ease of use, reflecting the company's commitment to excellence and customer satisfaction.









# THE UNRIVALED RELIABILITY OF GOLDEN BOAT LIFTS® WHY WE'RE YOUR TOP CHOICE

In the world of boating, reliability is paramount. Whether you're a seasoned sailor or a weekend cruiser, the last thing you want to worry about is the integrity of your boat lift. That's where Golden Boat Lifts® shines brightest. As the global leader in the marine industry with a legacy of excellence, we pride ourselves on offering the most reliable boat lifts on the market. Here are just a few examples:

## 1. Unmatched Quality Assurance

At Golden Boat Lifts®, quality isn't just a promise; it's a guarantee. We go above and beyond industry standards to ensure every component of our boat lifts meets the highest level of craftsmanship. From marine-grade materials to precision engineering, our lifts are built to withstand the rigors of the marine environment, providing you with peace of mind for years to come.

We are the only boat lift company to be certified by DQS Inc. to ISO 9001:2015. This level of recognition means we have upheld and enhanced customer satisfaction to the fullest through the effective application of our systems including consistent products and services that meet the applicable statutory and regulatory requirements set forth by ISO.







## 2. Innovative Technology

Innovation is at the heart of everything we do. Our engineering team is constantly pushing the boundaries of boat lift technology to deliver cutting-edge solutions that enhance performance and reliability. One prime example of having the most reliable boat lifts in the industry is our patented Sea-Drive® technology with a self-locking worm gear, eliminating the need for electric breaks, offering unparalleled safety and durability. Even after a hurricane, where places might have lost power, the Sea-Drive® can be manually operated.

## 3. Rigorous Testing Process

Before any Golden Boat Lift® leaves our facility, it undergoes rigorous inspections to ensure it meets our stringent quality standards. From load capacity assessments to corrosion resistance tests, every aspect of our lifts is thoroughly evaluated to guarantee reliability in real-world conditions. We double all our safety standards compared to the competition. It's this commitment to excellence that sets us apart.

## 4. Customization Options

We understand that every boat and waterfront is unique, which is why we offer a wide range of customization options to suit your specific needs. Whether you require an elevator lift, a floating lift, or a custom-designed solution, our team will work closely with you to create a lift that seamlessly integrates with your dock and enhances your boating experience.

## 5. Exceptional Customer Support

At Golden Boat Lifts®, our dedication to reliability doesn't end with the sale. We stand behind our products with exceptional customer support, ensuring you receive prompt assistance whenever you need it. Whether you have questions about installation, maintenance, or troubleshooting, our knowledgeable team and our premium marine contractors are here to help every step of the way.

## 6. Industry-Leading Patents

Golden Boat Lifts® isn't just a company; we're pioneers in the marine industry. With a portfolio boasting more patents than any other boat lift company, we're constantly revolutionizing to bring you the most advanced solutions on the market. Our dedication to research and development has resulted in groundbreaking technologies that redefine the way boat lifts operate. When you choose Golden Boat Lifts®, you're not just investing in a product; you're investing in a legacy of innovation and excellence.

When it comes to reliability, Golden Boat Lifts sets the standard. With unmatched quality, innovative technology, rigorous testing, customizable options, and exceptional customer support, we're the top choice for boat owners who demand nothing but the best. Experience the difference for yourself and elevate your boating experience with Golden Boat Lifts®. When it's done right, It's Golden!



# FLOATING DOCK LIFT

FLOATING DOCK LIFT:  
SEAMLESS ACCESS TO THE WATER







The Floating Dock Lift is a cutting-edge solution designed to simplify the process of docking and launching boats. Engineered for strength and stability, this exceptional lift accommodates various vessel sizes, ensuring reliable performance across all water conditions. The Floating Dock Lift features user-friendly operation and requires minimal maintenance, making it an ideal choice for boaters who value convenience and efficiency. With a commitment to quality and innovation, Golden Boat Lifts® provides a reliable option for those looking to maximize their time on the water. Discover how the Floating Dock Lift can transform your boating experience with ease and efficiency.



## CAPACITIES

7,000 lbs.	16,000 lbs.	30,000 lbs.
10,000 lbs.	20,000 lbs.	40,000 lbs.
14,000 lbs.	24,000 lbs.	50,000 lbs.

\*Larger capacities available upon request

\*Golden has been certified by DQS Inc. to ISO 9001:2015  
(see Pages 26-27 to learn more about our ISO certification)



# DECK LIFT

DECK LIFT:  
VERSATILE & CONVENIENT







The Golden Deck Lift provides you with a convenient, attractive and absolutely flawless extension of your dock and waterfront property. The low-profile versatile deck lift can be utilized in a variety of applications from lifting boats, dual jet skis, paddle boards and kayaks, or just having it as an added extension of your dock. Our Deck Lift gives you the ability and access to service and maintain your vessel from 360 degrees with hassle free convenience. The Golden Deck Lift is also compatible with our Elevators, 4-Posts, 8-Posts, and the Gatorvator® series line of lifts. When it comes to decking, the lift can be decked with a variety of different style materials and various color options of composite decking. For the environmentally sensitive areas, we utilize an anti-slip composite grated decking which allows sunlight to still penetrate down to the sea or lake floor.





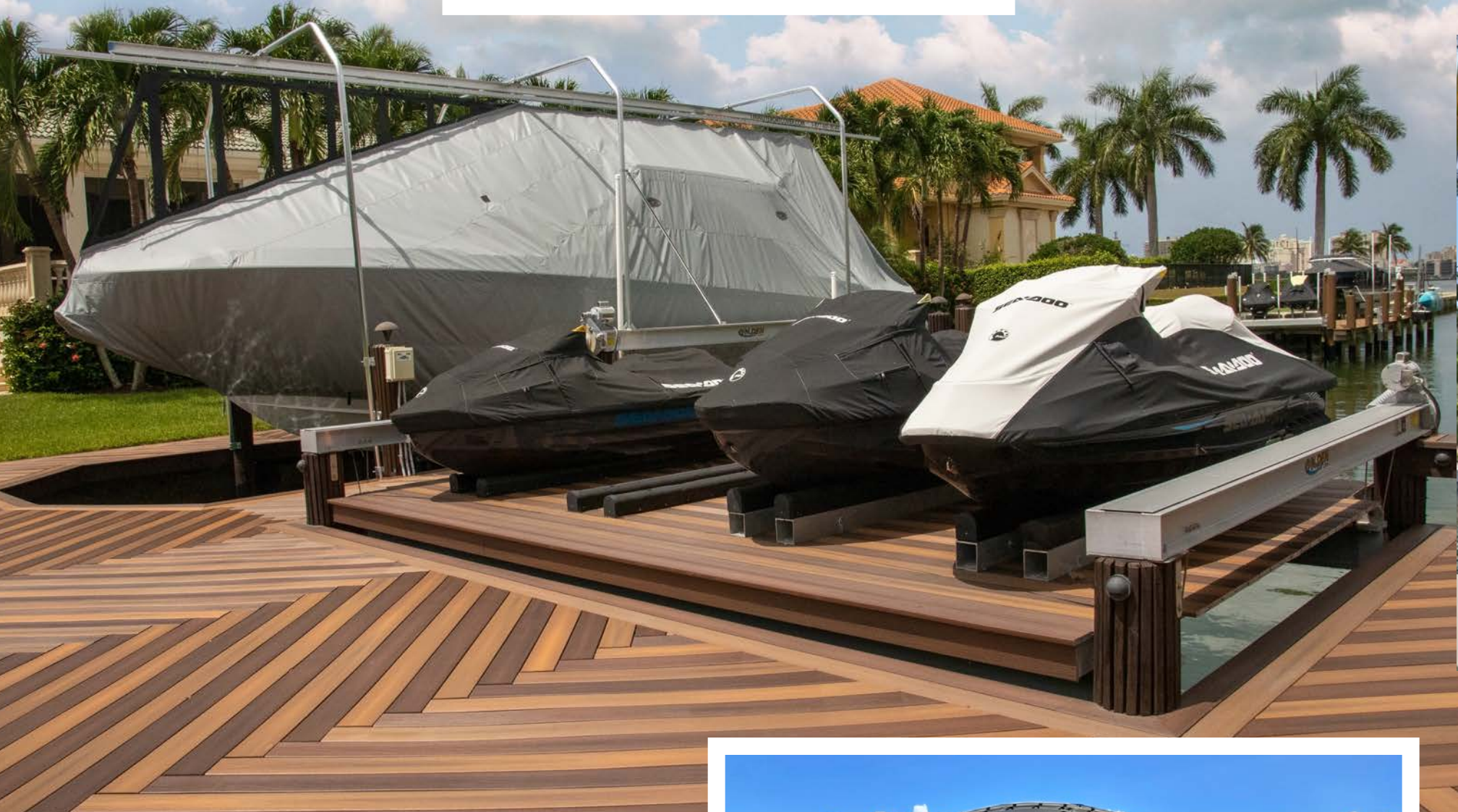

# DECK LIFT





## FEATURES

- Anti-slip decking
- Available in various colors
- Decks can be custom built to fit all Golden Boat Lift® capacities and styles
- Adds convenience for complete access to your personal watercraft or boat
- Eco-friendly; does not block sunlight which allows the seagrass to grow
- The Sea-Drive® is warranted for 10 years
- Multiple colors and decking options
- Golden has been certified by DQS Inc. to ISO 9001:2015 (see Pages 26-27 to learn more about our ISO certification)





# JS-1400

## PWC LIFT

THE SUPREME JET SKI  
DOCKING SOLUTION







The Golden Boat Lift® JS-1400 is the ideal docking solution for jet ski owners seeking convenience and reliability. Designed specifically for personal watercraft, this cost effective lift offers a user-friendly experience, ensuring easy access and storage for your jet ski. The JS-1400 is crafted from high-quality, marine-grade materials that resist corrosion and withstand the harshest marine environments, providing you with a long-lasting and low-maintenance solution. With a smooth lift mechanism and a sturdy platform, the JS-1400 allows for effortless launching and docking, so you can spend more time enjoying the water. Trust Golden Boat Lifts® to deliver a product that combines safety, functionality, and innovation for the perfect jet ski docking experience.



\*Golden has been certified by DQS Inc. to ISO 9001:2015  
(see Pages 26-27 to learn more about our ISO certification)



# JS-1500R

## PWC LIFT

PREMIUM JET SKI LIFT FOR  
EFFORTLESS ACCESS & STORAGE







The Golden Boat Lift® JS-1500R is the ultimate lift for jet ski enthusiasts who value efficiency and durability. Engineered for ease of use, this lift provides a secure and stable platform for storing and accessing your personal watercraft. Constructed with high-quality, marine-grade materials, the JS-1500R is designed to withstand harsh marine conditions, ensuring long-lasting performance and minimal maintenance. Its effortless lift mechanism allows for quick and simple launching and docking, giving you more time to enjoy the water. With a focus on safety and reliability, the JS-1500R is the perfect solution for enhancing your waterfront adventures and protecting your investment.



\*Golden has been certified by DQS Inc. to ISO 9001:2015  
(see Pages 26-27 to learn more about our ISO certification)



# KAYAK LAUNCH®

PATENT #: 9,278,735

## EASY LAUNCHING FOR EVERY ADVENTURE

Golden Boat Lifts® presents its premier Kayak Launch®, the incredible solution for hassle-free access to the water. Engineered for stability and ease of use, this launch system provides kayakers and paddleboarders with a secure and stable platform, making entry and exit a breeze. Built with durable, marine-grade materials, it withstands various water conditions while requiring minimal maintenance. Whether you're a seasoned paddler or a beginner, our Kayak Launch® is designed to enhance your kayaking or paddleboarding needs by providing unmatched convenience and safety. With a Golden Boat Lift® Kayak Launch®, you can focus on enjoying your adventure on the water with confidence and peace of mind.

### 5 STEP LAUNCH MODELS

STANDARD: 4' Travel, 6' Bunks, 34" Clear Entry  
EXTRA WIDE: 4' Travel, 6' Bunks, 43" Clear Entry  
HEAVY DUTY: 3' Travel, 6' Bunks, 56" Clear Entry

### 7 STEP LAUNCH MODELS

STANDARD: 6' Travel, 6' Bunks, 34" Clear Entry  
EXTRA WIDE: 6' Travel, 6' Bunks, 43" Clear Entry  
HEAVY DUTY: 5' Travel, 6' Bunks, 56" Clear Entry

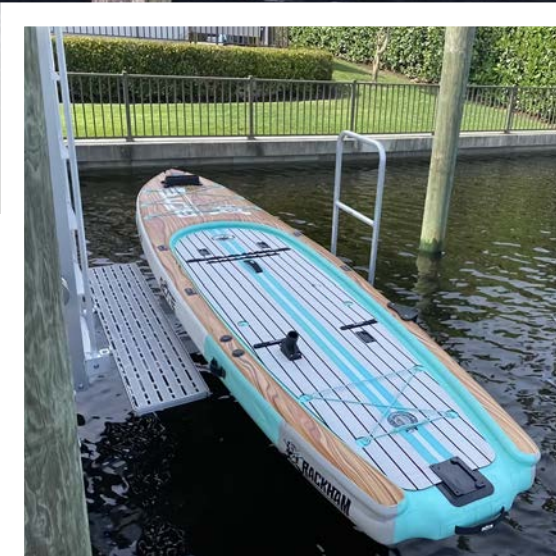



# FLOATING KAYAK LAUNCH®

## GLIDE INTO THE WATER WITH EASE & STABILITY

The Golden Boat Lifts® Floating Kayak Launch® attaches to most residential floating dock systems. It adjusts to changing water levels, ensuring a smooth and secure entry and exit from your kayak. Constructed from high-quality, marine-grade materials, the Floating Kayak Launch® is designed to withstand various weather conditions while requiring minimal maintenance. Its user-friendly design caters to paddlers of all skill levels, offering unparalleled stability and ease of use. With the Golden Boat Lifts® Floating Kayak Launch®, you can enjoy a seamless transition from land to water, making every kayaking and paddleboarding adventure more enjoyable and stress-free.

### FLOATING LAUNCH MODELS

- STANDARD: 6' Bunks, 34" Clear Entry
- EXTRA WIDE: 6' Bunks, 43" Clear Entry
- HEAVY DUTY: 6' Bunks, 56" Clear Entry

\*Golden has been certified by DQS Inc. to ISO 9001:2015 (see Pages 26-27 to learn more about our ISO certification)

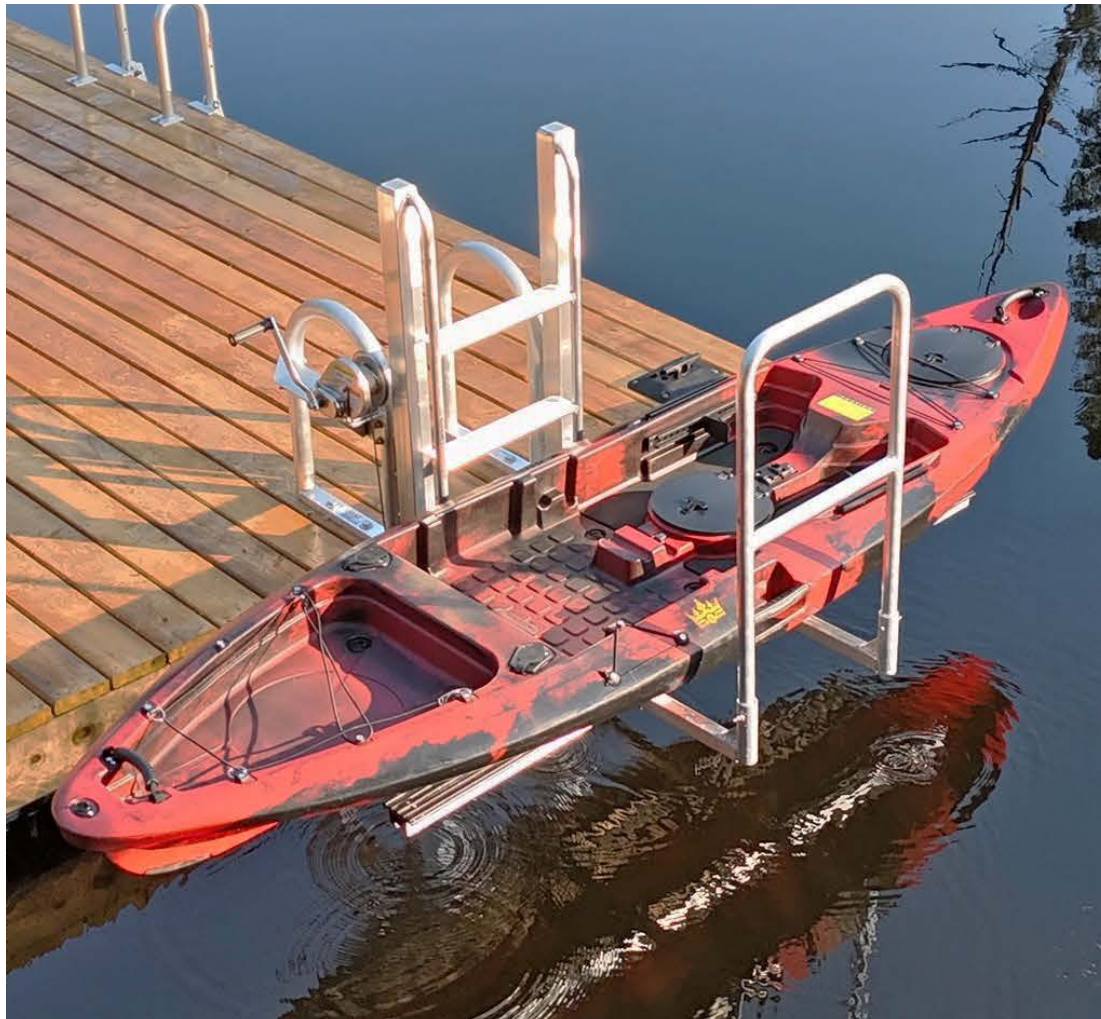



# GOLDEN SEA-DRIVE®

PATENT #: 7,850,147

## POWERFUL, EFFICIENT & ECO-FRIENDLY BOATING SOLUTIONS



The patented Golden Sea-Drive® is a revolutionary propulsion system that combines power, efficiency, and eco-friendliness to deliver an exceptional boating experience. Designed with advanced technology, the Sea-Drive® offers quiet and smooth operation, reducing noise pollution and minimizing environmental impact. Its robust design ensures reliability and longevity, making it an ideal choice for environmentally conscious boaters who seek both performance and sustainability. Experience the future of boating with the Golden Sea-Drive®, where innovation meets responsibility.





# IMITATED BY MANY, MATCHED BY NONE: THE GOLDEN SEA-DRIVE® DIFFERENCE



The Golden Sea-Drive® utilizes its proven double reduction worm gears so there are no chains to break or belts to slip. It's engineered so the main gear that supports the load will never back drive, eliminating the need for unreliable electronic brakes.

While the Golden Sea-Drive® has always been a low-maintenance item, it now boasts a heavier cast housing made from a new alloy for greater corrosion resistance. To improve internal component lubrication, it's packed with high-viscosity grease that won't leak from the unit, even on the hottest days. Even the bearing caps have been improved and are now 300 series stainless steel. The drive bolt is 5/8" oversized hardened steel and with over 8,000 inch-pounds of torque the Golden Sea-Drive® is twice as strong as its nearest rival.

First introduced in 2008, the Golden Sea-Drive® is backed by a 10-year warranty.





# THE COMPETITIVE ADVANTAGE

## GOLDEN BOAT LIFTS®

## COMPETITORS

### WARRANTY

- 15-year warranty on structure
- 10-year warranty on Sea-Drive® (Patent # 7,850,147) gear box
- 2-year bumper to bumper warranty

- 10-year warranty on structure
- 2-5 year warranty on gear box
- 1-2 years on all other components

### DRIVE UNIT

- Sea-Drive®: Double Reduction Worm Gear. Packed with synthetic grease so there is no oil to leak, no chains to break, and no service ever needed.
- Sea-Drive® unit: 8,000 Inch-Pounds of Torque at 1 HP input.
- All hardware is 300 series stainless steel
- Heavy duty injected die-cast aluminum housing
- Over 15 years without failure
- 5/8" Drive Bolt

- Direct Drive: Require electric brakes with heavy loads
- G3: New to industry / Has not lived its warranty
- G6: New to industry / Has not lived its warranty
- H2: Motor in vertical position, allowing water into the upper motor bearing
- Chain Drive: Motor in vertical position, allowing water into the upper motor bearing
- 1/2" Drive Bolt

### CABLE & WINDER ASSEMBLY

- Cable Retention Bolt (Patent # 6,719,241) & Anti-shear cable guard (Patent # 10,189,685)
- 3.5" dia. & large cable spool
- Certified stainless steel cables

- Cable Retention Bolt: Not available
- Anti-Shear Guard: Not available
- 2.375"-3" dia. cable spool
- Unknown material

### PATENTS

- Sea-Drive®: 8,000 Inch- Pounds of Torque, Self-Locking worm gears
- Cable Retention Bolt: Ensures your cable is safely attached to the winder
- Anti-shear cable guard: Ensures your cable will not run off the winder when it is at its last groove and eliminates shear between the winder & bearing

- No Self-Breaking gears: 4,000 +/- Torque
- No Patented Cable Retention Bolt. Feed cable through shaft
- No Patented Anti-Shear Guard. Cable will shear and drop boat if cable runs off spool.

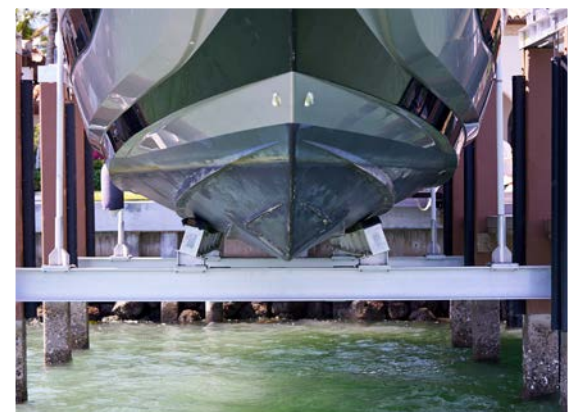



## GOLDEN BOAT LIFTS®

## COMPETITORS

<b>ALUMINUM PLATES</b>	50% thicker than the industry standard: 3/8" plate	Industry standard: 1/4" plate
<b>HARDWARE</b>	3/4 stainless steel bolt, 300 series stainless steel	Unknown materials
<b>LIMIT SWITCH</b>	Patented limit switch cover	No limit switch cover, making it susceptible to the rigorous weather.
<b>POSITION OF MOTORS</b>	Horizontal stainless steel motor. Two weep holes. Water drains out. Doesn't affect any components	Vertical. Water will sit on the top bearing and get down in the centrifugal switch, which wears out quicker and making noises.
<b>PULLEY SYSTEM</b>	Leaded bronze bushing with grease fitting. Lead for lubricity and bronze for hardness.	Powder bushing or oil light bushing which tends to squish out over time.
<b>AXLE BOLTS</b>	3/4" or 1"	3/4"





# HEROES IN ACTION TRUST GOLDEN

- Punta Gorda Police Department: Brand new (2) 4-Post Boat Lifts in the beautiful Laishley Park Marina.
- Fort Myers Fire Department: Platform lift, purposely slanted to get in and out quickly.
- Sanibel Police Department: There is only one reason why you should choose Golden over any other lift, we last. Through the most treacherous hurricane in SWFL history, our boat lifts are built to withstand the toughest and most catastrophic storms.
- Other Municipalities: Bradenton, Sarasota, St. Pete, Lee County Sheriff, Bay Harbor Islands and others.



“WE FAR OUTLIVE OUR WARRANTIES, BUT WE WANT YOU TO HAVE A PRODUCT THAT IS NEVER GOING TO BE A PROBLEM. THE ONLY WAY TO DO IT IS TO TRULY OVERBUILD.”

**BILL GOLDEN · CEO, OWNER**





Golden Boat Lifts® has established itself as the trusted partner for government agencies globally, renowned for its exceptional quality, reliability, and innovative solutions. With decades of experience in the marine industry, Golden Boat Lifts® consistently delivers robust and tailored lift systems that meet the stringent standards and diverse needs of government projects. Our commitment to excellence is evident in every aspect of our operation, from meticulous engineering to unparalleled customer service. This dedication ensures the longevity and safety of government-owned marine assets, making Golden Boat Lifts® the go-to provider for agencies seeking dependable and efficient solutions. Our global presence and proven track record affirm our capability to support and enhance governmental maritime infrastructure, solidifying our reputation as the industry's premier partner.





# WHEN OTHERS FAILED, OURS STAYED



Hurricane Ian put us all to the test. And when it tested the strength of our many marinas and docks on Fort Myers Beach and San Carlos Island, Golden Marine Systems® lived up to our name, riding the storm out when others failed. Even better, our docks gave emergency marine patrol teams and other first responders precious and dependable dock space to tie their various vessels to. This allowed them to be more effective in the daunting tasks of rescue, cleanup and restoration.





# TRUSTED BY FLORIDA'S FINEST

Client: Manatee County Marine Unit Vessels: 32' Intrepid, 26' Gause Built, 19' Carolina Skiff 198 DLV, 15' Jon Boat  
Product: (4) 4-Post 2-Motor Boat Lifts



Client: Cocoa Beach Police Department Product: (2) 4-Post 2-Motor Boat Lifts



Nestled in the Marjorie Park Marina, the Tampa Bay Police Department relies on Golden's two 20K 4-Post Boat Lifts.



The Bradenton Police Department's Golden Boat Lift has withstood the test of time with over 25 years in service.



Client: St. Augustine Fire Department Product: (2) 4-Post 2-Motor Boat Lifts.



# THE POWER BEHIND MIAMI BEACH'S POLICE DEPARTMENT IS GOLDEN



Golden Boat Lifts® has proudly collaborated with the Miami Police Department, one of the largest metropolises in the United States, by earning their trust with our top-notch boat lifts! When the Miami Beach Police Department reached out to us with their boat lift needs, we jumped into action. Working closely with them, we designed the perfect application, culminating in the installation of a 4-Post 2-Motor Boat Lift. But we didn't stop there - we equipped it with Golden's exclusive Sea-Drive®, ensuring faster and more reliable lifting and lowering of their emergency water vessels providing safety in a demanding market.

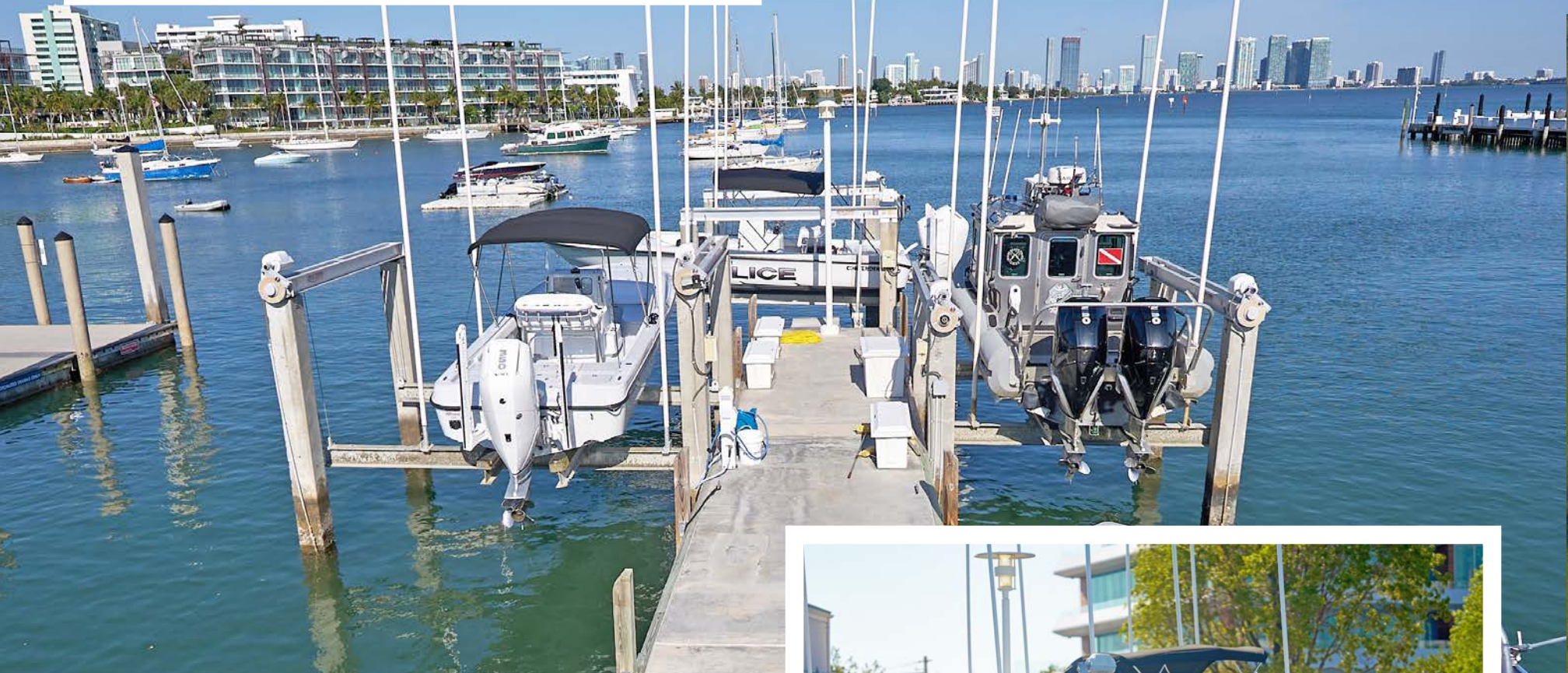

“Golden Boat Lifts® has been a game-changer for our marine unit. We had these lifts for at least 10 years. We need dependability. When we need them to work, they work. We can never take that chance of them not working that is why we have always been a Golden customer. They work as they should. We have never had an issue. We are redoing the building and combining police and fire departments. The Golden Elevator Lift will be the only lift we use for our new 40' fire cabin boat.”

- Sargent Duane Rezend, Marine & Underwater Recovery Unit, Miami Beach





# ENHANCING KEY LARGO STATION WITH STATE OF THE ART FLOATING DOCKS & BOAT LIFTS

The National Park Service of Key Largo selected Golden Marine Systems® to provide floating docks and boat lifts for the Key Largo station site. Golden delivered their 850 Series aluminum dock system featuring Endeck Coastal Gray decking, 12" GMS adjustable cleats, pile guides, and finger piers. A 4' wide by 20' long gangway was also part of the package. The Golden Boat Lifts® supplied four 10K boat lifts complete with remote control and auto stop features, adding another layer of convenience and functionality, making it easier to store and access the boats quickly and safely.





# THE NATION'S CHOICE FOR MARINE EXCELLENCE

Golden Boat Lifts & Marine Systems® is the trusted choice for national government municipalities, offering unmatched quality and reliability in marine solutions. Our state-of-the-art boat lifts and dock systems are engineered to meet the rigorous demands of government operations, ensuring dependable performance and safety. With a proven track record of excellence, Golden provides the innovation and durability that national agencies rely on to manage and protect their waterways. Choose Golden Boat Lifts & Marine Systems for marine solutions that set the standard for quality and performance.



Client: Mobile Fire Department, Alabama  
Vessel: Steel Shark  
Product: 40K 8-Post Boat Lift



Client: Texas Navy Base  
Products: (3) Elevator Lifts

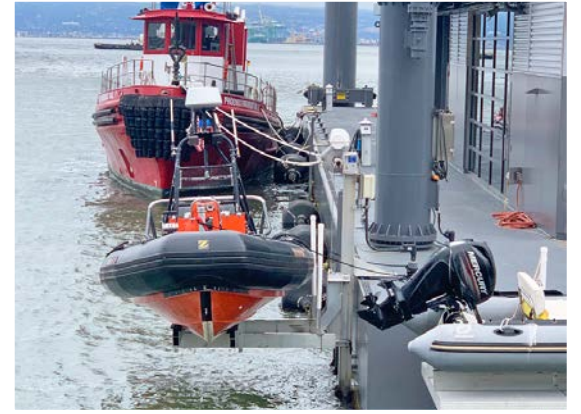

Client: San Francisco Fire Department  
Product: (2) Custom 3K Single-Track Elevators with Platforms & Aluminum Bunks

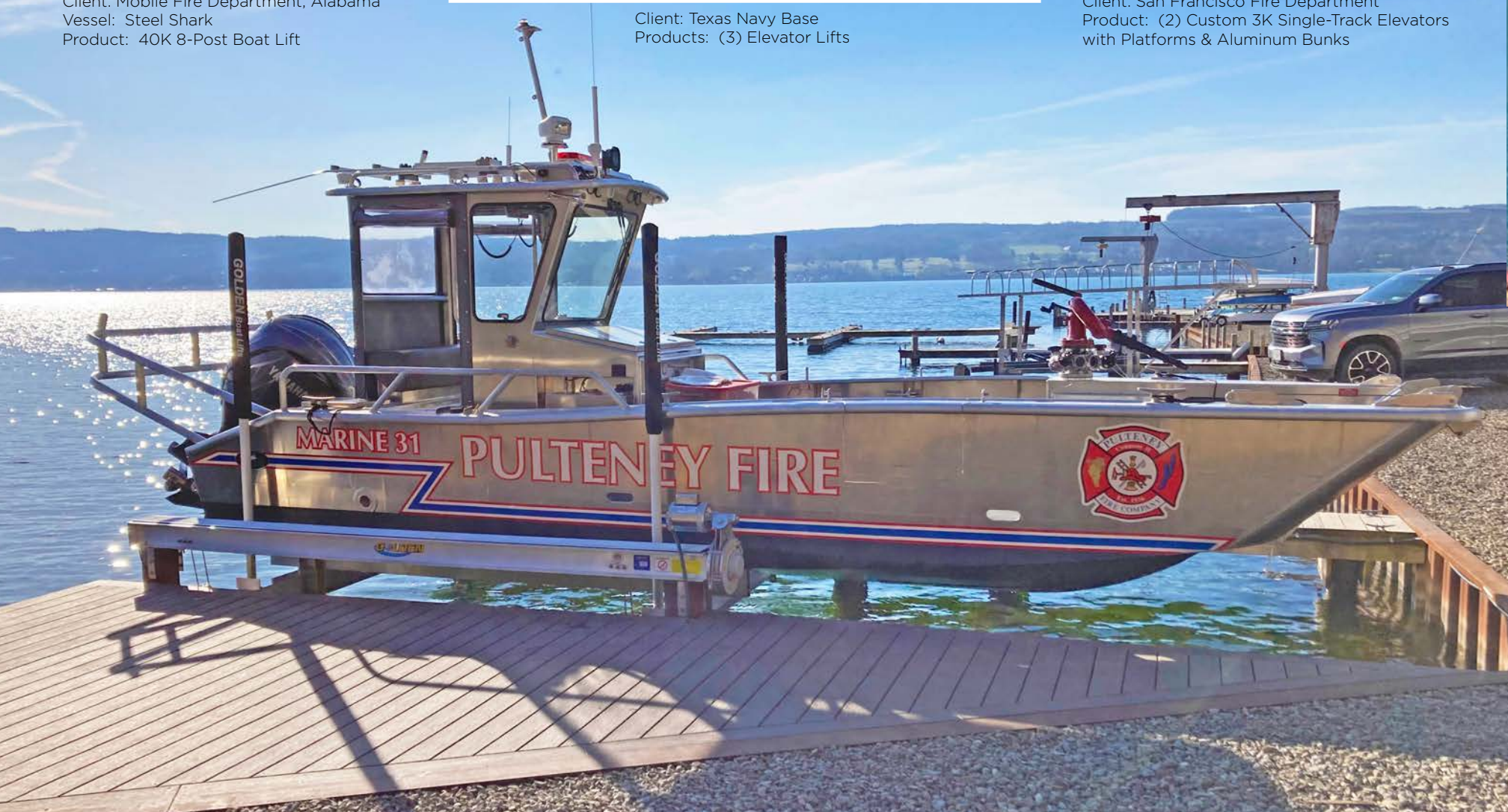

Client: Pulteney Fire NY  
Product: Low Profile 4-Post Boat Lift with Patented Sea-Drive®





Client: Aruba Police Department  
 Brief: We built a 4-Post Boat Lift for the Aruba Police Department over ten years ago and it is still going strong and in use today, looking brand new.



Client: Malaysian Police Department  
 Product: (2) 2-Motor Low Profile Lifts



Client: Republic of Panama  
 Brief: Due to the extreme water rise in the lock, the Elevator Lifts travel 30' - double what is typically needed. Because of this, everything about the project is oversized and overbuilt.



Client: Sweden Sea Rescue  
 Product: Flat Plate Drive Elevator



# ACCESSORIES

## BRIDGING THE GAP

Golden Boat Lifts & Marine Systems® offers sleek platforms and walkways designed to enhance access and functionality on the water. Crafted from high-quality, marine-grade materials, our platforms and walkways provide both durability and elegance, integrating with any waterfront setting. With a focus on safety and functionality, our designs ensure stable and secure access to your watercraft, making them ideal for residential, commercial and governmental use. The customizable options allow for a tailored fit to meet specific needs and aesthetics, whether it's a simple dock or a more complex setup. Experience the perfect blend of style and practicality with Golden Boat Lifts & Marine Systems, where our platforms and walkways set the standard for excellence in marine infrastructure.

## PLATFORMS & WALKWAYS:



Hinged Boarding Platform

Our hinged folding platforms come in three standard sizes, but we can make them custom-fit for your boat lift and the space around it, whether it's your dock or seawall. These platforms let you easily get on and off your boat, bridging the gap between your boat and the dock or seawall. Plus, they can fold up and lock away when you don't need them, keeping them out of the way.



Boarding Platform

Manufactured in two standard sizes, 3' X 4' & 3' X 5'. Made to mount directly to the dock and fill the gap between dock and boat lift for ease of boarding.



Elevator Boarding Platform

Bridge the gap between dock or seawall and boat lift for ease of boarding. Customizable to match Elevator Lift's track-spread and dimensions.



Walkway

Walkways are designed for easy access for boat owners to access and maintain their boats' exterior from bow to stern or in between and offer peace of mind for cleaning and maintenance. Our walkways come in standard nominal lengths and also can be made custom to fit your boat lift application.



Stern Platform

Made to provide access to your out drives or motors. Standard length is 16'.

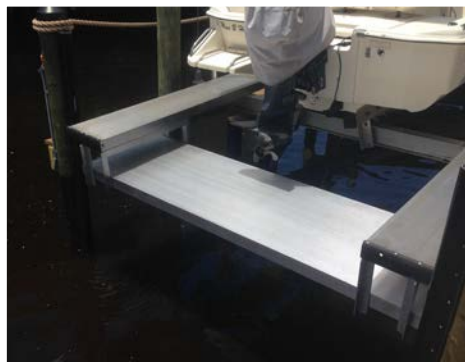

Walkaround Stern Access Platform

Customizable to mount directly on-to lateral boarding platforms available for 4 and 8 post lifts to access the stern of the boat. Designed to still allow boat's entry while providing access to its transom, motor, lower-units, props, or simply cross to the outer platform on your lift.



Stairs/Steps

Steps are designed and made for easy boarding access onto your boat and can be made to fit custom heights. They also can be fabricated with or without a handrail for each application and mount directly to your walkway.



Titan Platform

Our platforms are made using durable aluminum framing and are dressed with titan decking, a barefoot friendly synthetic dock deck surface with light penetration. They are fully customizable in size, shape, and color. Frame-only options and other decking options also available upon request.





## OTHER ACCESSORIES:



Tide Guides

These keep your boat cradle in place when there's strong water flow. They're placed on all four corners of the cradle beams to stay aligned with the poles.

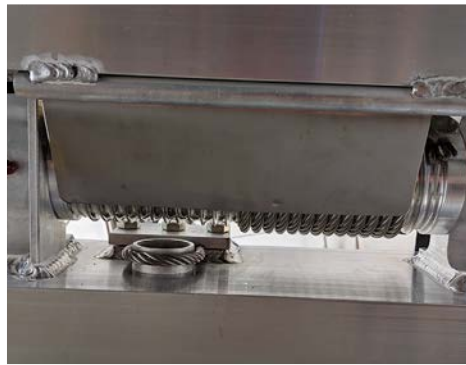

Cable Keepers

These keep your lift cable in place, especially useful in rough waters. You can add these to a 4-Post or 8-Post lift if you want.



Anodized Winders

Protects the winders from a heavy salt water environment.



Top Beam Covers

Commonly used in a low profile installation so that the top beam can be used as a walk platform. Made to fit each specific lift size.



Remote Controls

To conveniently gain access to the water and storage when done using the boat.



Limit Switches

Safely stopping the vessel at the appropriate height for storage and correct depth for access to the water.

Patent #12,030,602



Limit Switch Cover

Patented device to keep the limit switch in use for years of service.



Electric Motor Cover

Cover to protect the motor, keeping them safe and reliable.



# GOLDEN MARINE SYSTEMS®

## LEADING THE WAVE: GOLDEN MARINE SYSTEMS SETS THE STANDARD IN DOCK SOLUTIONS

Golden Marine Systems®, LLC (GMS) stands as a beacon of excellence in the marine industry, nestled in North Fort Myers, Florida. With a legacy spanning over 35 years, we have honed our craft as premier manufacturers of floating aluminum and concrete dock systems, as well as gangways that set the standard for innovation and reliability.

Our state-of-the-art facility encompasses over 40,000+ square feet, employing a dedicated team of 100+ support staff, each meticulously trained to uphold our commitment to excellence. At GMS, we believe in the power of ingenuity, blending creativity, cutting-edge technology, and rigorous design methodology to craft dock systems that transcend expectations.

Driven by a passion for innovation, our team of design and engineering professionals constantly push the boundaries, setting new benchmarks in the industry. With a keen eye for detail and an unwavering commitment to quality, we ensure that every product bearing the GMS logo is a testament to durability, dependability, and aesthetic finesse. From concept to completion, every step is guided by a relentless pursuit of perfection, ensuring our structures not only stand true but also exude unparalleled craftsmanship.

The trust and confidence of our clients worldwide stand as a testament to the principles upon which Golden Marine Systems®, LLC was founded. As stalwarts in the marina industry, we remain steadfast in our commitment to setting newer and higher standards, propelling the industry forward one dock system at a time.

Our highly trained design and engineering professionals combine an emphasis on creativity, technology and design methodology to develop detailed designs and innovations. Our team of professionals strive to continually set newer and higher standards industry wide.

The principals of Golden Marine Systems®, LLC's experience, quality approach and presence in the marina industry have earned them the respect and confidence of clients worldwide.





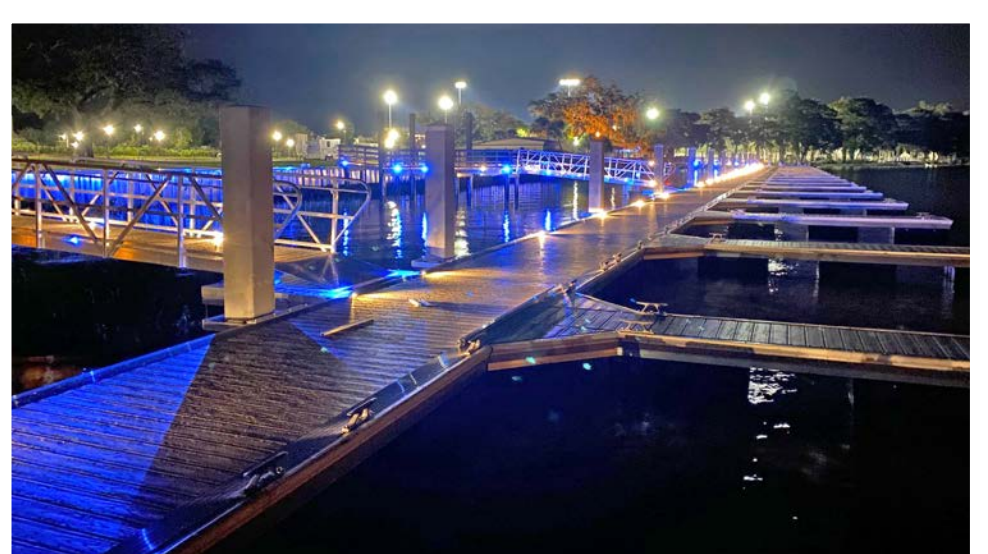



# RESIDENTIAL DOCKS

TRANSFORM YOUR WATERFRONT  
INTO A PERSONAL OASIS







Golden Boat Lifts and Marine Systems offers incredible residential docks designed to enhance your waterfront lifestyle with elegance and functionality. Our residential docks are crafted from high-quality materials to ensure long-lasting durability and aesthetic appeal, making them a perfect addition to any waterfront property. Whether you need a simple docking solution or a more elaborate setup with integrated features, our docks are customizable to meet your unique needs and preferences. With a focus on safety and convenience, Golden residential docks provide easy access to your boats and watercraft, creating a streamline connection between your home and the water. Trust in our expertise and craftsmanship to deliver a dock that complements your home and elevates your waterfront experience.

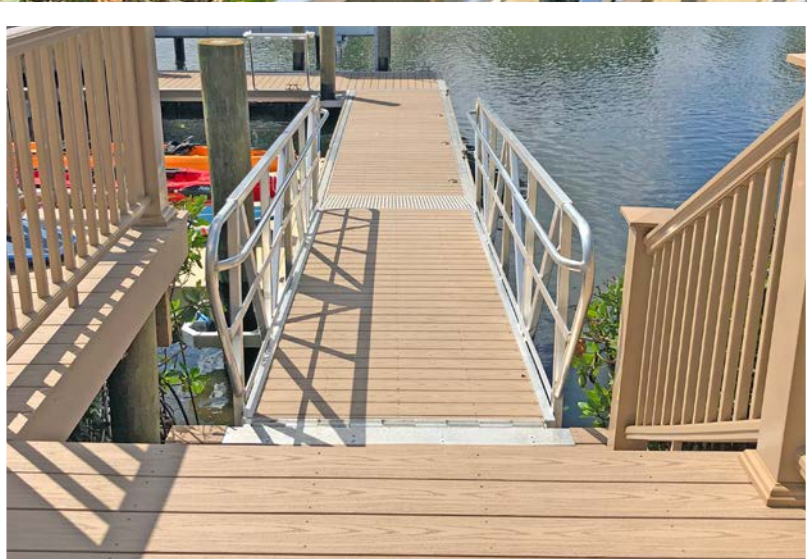



# FLOATING DOCKS

## FLOAT ABOVE THE REST WITH OUR SUPERIOR DOCKS

Our aluminum floating docks are designed and manufactured for each project's specific design criteria. The docks are manufactured to withstand the elements of nature and time with a life expectancy of 35+ years.

Golden Marine Systems, LLC® offers an industry-leading 10-year limited warranty. Our aluminum dock systems are virtually maintenance-free.

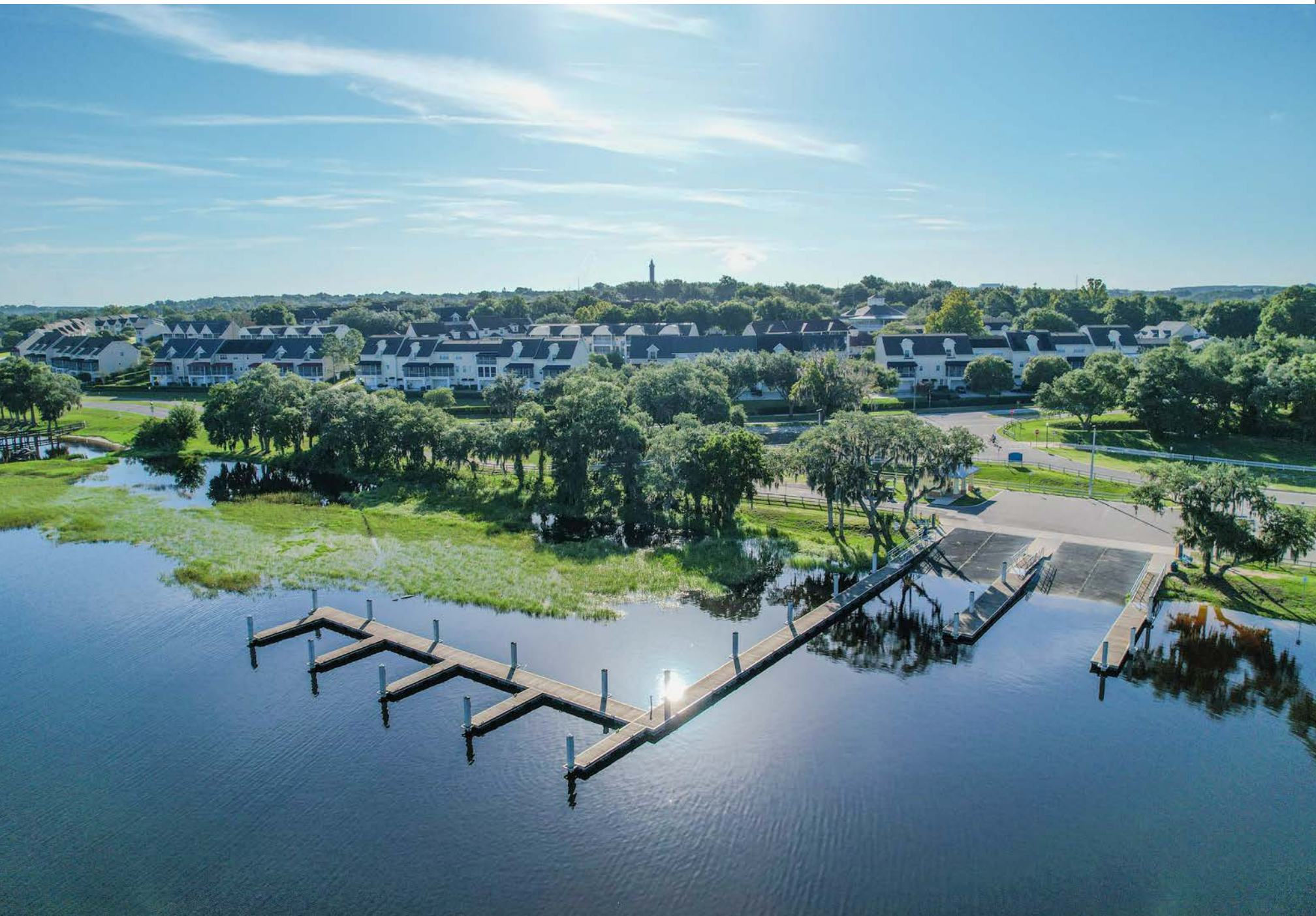



## MANUFACTURING:

Our dedicated workforce is professionally trained. Processes and procedures are in place to assure that our structures are manufactured correctly to the highest quality. Attention to detail is taken to both ensure product dependability and finished aesthetics.

## DESIGN & ENGINEERING:

Our highly trained design professionals combine an emphasis on creativity, technology, and design methodology to develop detailed plans and innovations. We work closely with clients and engineering firms to ensure proper specifications, practicality and system functionality. Our team of professionals continually strive to set newer and higher standards industry-wide.

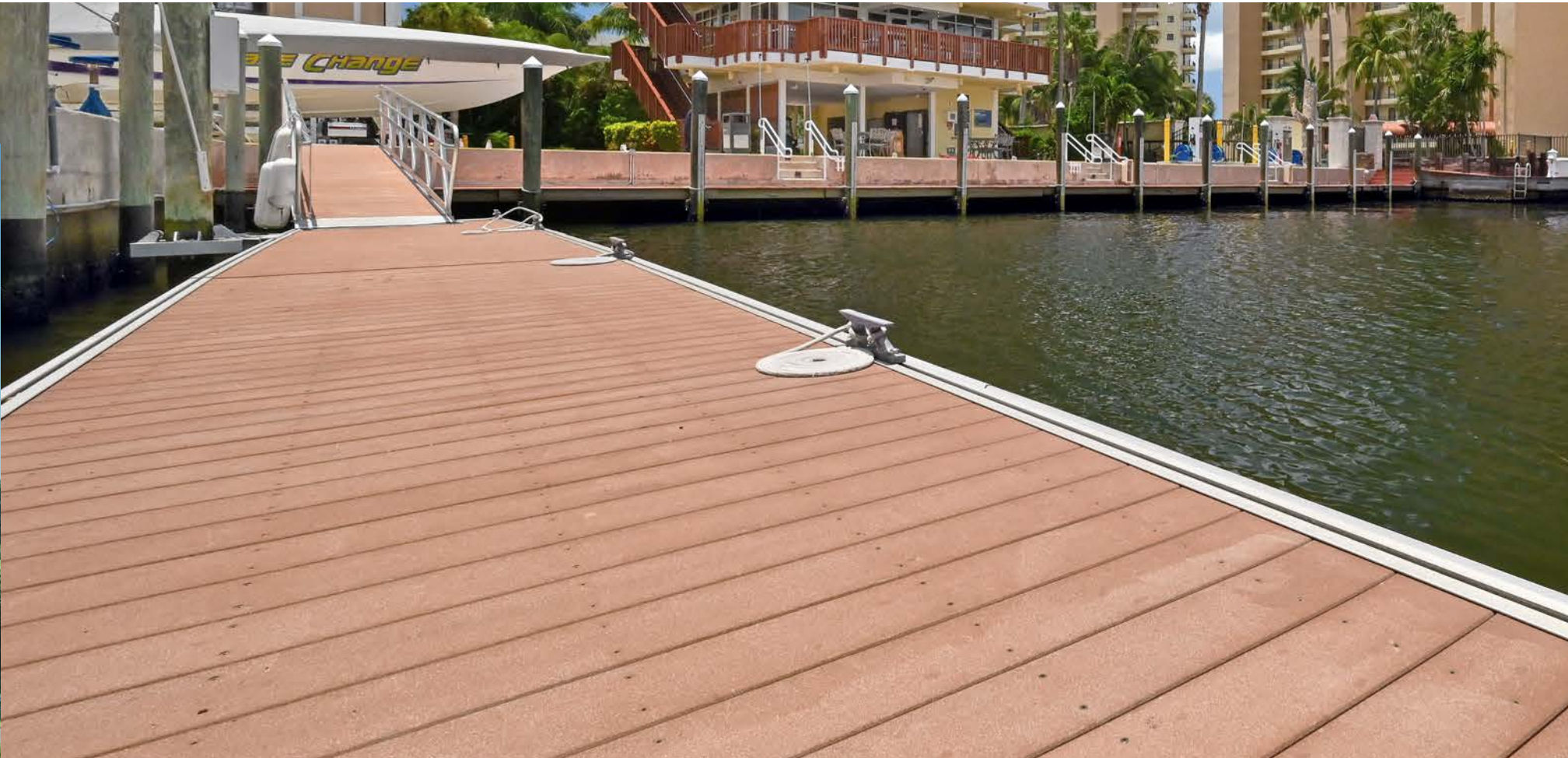

## ALUMINUM DOCK HIGHLIGHTS:

- 6061-T6 Marine Grade Aluminum and 300 Series Stainless Steel
- Noise-free rubber Flexi-Block connections
- Golden's single and double track extrusion allows for a multitude of accessories to easily attach and adjust
- Adjustable cleats, pile guides, and finger piers
- A variety of decking options including composite, natural hardwoods, decorative brick pavers, and polypro grated decking
- Service utility troughs for easy installation and maintenance
- Built by a solid company with a Golden reputation in the marine industry



# PINK SHELL MARINA

DON'T CALL IT A COMEBACK:  
GOLDEN MARINE SYSTEMS® RESTORES  
PINK SHELL'S COASTAL CHARM





At Pink Shell Marina in Fort Myers Beach, Florida, a vision of excellence was brought to life with the help of Golden Marine Systems®. Our team collaborated closely with the marina owners to implement a comprehensive solution that would elevate their facility to new heights of functionality and aesthetics after the destruction of Hurricane Ian. The chosen solution? Golden Marine Systems® acclaimed 850 Series Single Track system, paired with Endeck® Ashwood PVC decking for durability and visual appeal. This combination not only provided exceptional performance but also enhanced the overall aesthetic allure of Pink Shell Marina.

One of the standout features at Pink Shell Marina is its adjustable cleats, pile guides, and utility troughs. These features were strategically integrated to streamline operations and ensure efficient docking for boaters. Additionally, our gangways provide safe and convenient access to boats, enhancing the overall boating experience for marina visitors.

The successful completion of the Pink Shell Marina project is a testament to Golden Marine Systems® commitment to excellence and customer satisfaction. Our team's expertise, combined with our premium marine system solutions, has helped Pink Shell Marina establish itself as a premier destination for boaters in Fort Myers Beach, once again.

As we celebrate the achievement of the Pink Shell Marina project, we invite you to explore how Golden Marine Systems® can elevate your marina to new heights. Contact us today to learn more about our innovative solutions and start your journey towards a more functional and aesthetically pleasing marina experience. Together, let's make your marina the envy of the coast!





# PINK SHELL BEACH RESORT & MARINA IS BETTER THAN EVER AFTER HURRICAN IAN

After being nearly destroyed when Hurricane Ian made landfall in September 2022, Pink Shell Beach Resort & Marina in Fort Myers Beach, Florida, is open for the 2024 boating season. The Category 5 hurricane caused widespread destruction to countless businesses, residences and communities in western Florida, making 2023 a year of rebuilding. Faced with an abundance of necessary repairs, Pink Shell owners initiated their hotel remediation, then immediately called up Golden Marine Systems® to rebuild the marina.





## Evaluating the Damage

For days following the storm, search and rescue efforts took the place of ordinary operations for most southern Florida businesses. At Pink Shell Resort, Ian's 19-foot storm surge pummeled the first and second floors but failed to compromise the structural integrity of the iconic hotel. In no time, Pink Shell opened its doors to provide accommodation for relief workers, contractors and some displaced residents. On the mainland, Golden Marine Systems® Fort Myers facility sustained damage as well.

After wellness checks to confirm the safety of its employees were conducted, Golden was up and running a week after the storm. "We had the typical roof damage and bay doors blown out," said Mike Shanley, president of Golden Marine Systems®. "Very quickly everything was boarded up and protected until it could be repaired."

Golden went right back to work manufacturing boat lifts and docks. "Within a matter of days, [Pink Shell] called me to rebuild the marina," Shanley remembers. "Within a day or two, I got the numbers together, they signed, and we went to work."

Dave O'Connor, manager of the Pink Shell marina, said all but five of the marina's 33 original steel piles survived the storm. Two days after the storm, we didn't have anything except the pilings," he recalled.

While only the five piles needed replacement, the new docking system would need to meet precise manufacturing specs to fit the existing piles. Tolerance for the new docking system to match the existing piles was 1/8 of an inch. "We had a center point survey done to identify the center of the piles and positions," Shanley said. "Then our engineers went to work and designed the docks, and we hit them spot on."

To expedite the project, the new docks matched the same footprint as the original dock layout. Golden replaced the floating main dock and 13 fingers for a total of 41 slips that will serve mostly transient boaters. "We didn't make any modifications," O'Connor said. "It's the exact same footprint." Maintaining the original marina footprint avoided re-permitting, which allowed construction to begin immediately.

The dock installation was performed by long-time Golden dealer RJ Gorman Marine Construction, based out of Panama City. "Golden did an outstanding job of fabricating the new docks to fit around the undamaged piles," said Jared Gorman, co-owner of RJ Gorman. "The installation went perfectly." With the dock system installed successfully, the full opening of the marina waited only for electrical panels, which O'Connor noted, along with switch gears, had been scarce due to local demand following the storm. The marina is currently fully operational and enjoying the best of the 2024 season.

## Protection Against Future Storms

The new docking system incorporates the Golden 850 Series Single Track System and Golden 100 Series Commercial Gangways, built of 6061-T6 aluminum to ensure strength against future storms. Proprietary features include the Integrated Tracks, which allow the marina to add and move cleats as needed for specific vessel sizes, while Flexi-Block connectors reduce dock noise as sections respond to wave activity.

O'Connor expressed sincere gratitude to the Golden team for their work. "Special thanks goes to Mike Shanley and the Golden production crew for their dedication, which facilitated the transformation of our space into a fully operational marina within 14 months, just in time for the season," O'Connor said. "Their commitment to our project was much appreciated."

In the rebuilding after Ian's landfall, Golden was awarded four other large marina rehabilitation projects in the area. "The three marinas that we did have on Fort Myers beach all survived, so that testimony sold itself," Shanley said.

Golden also assisted in reopening other Fort Myers Beach facilities, Moss Marine and Gulf Star Marina, rebuilding damaged gangways and dock sections. Federal agencies then utilized the marinas during search and rescue efforts on outer islands and coastal areas. "The response from local, state and federal was pretty intense," Shanley added, "the best I've ever seen."

# PINK SHELL MARINA



# SNOOK BIGHT MARINA

BREATHING NEW LIFE  
INTO EVERY BIGHT!





Welcome to the newly restored Snook Bight Marina, a Suntex property, proudly rebuilt by Golden Marine Systems® after the devastating impact of Hurricane Ian. Our state-of-the-art Golden Marine Systems® floating aluminum dock array now stands as the centerpiece of this world-class marina. Following the obliterating force of Hurricane Ian, which left Snook Bight Marina in ruins, Golden Marine Systems® stepped in to rebuild and restore this iconic waterfront destination. The storm's fury tore away all the marina's wet slips, fuel dock, and piles, leaving behind a trail of destruction. With eight feet of water flooding the marina office, store, and storage barn, the damage was extensive, including the loss of company forklifts.

Undeterred by the challenges, Golden Marine Systems® swiftly initiated the fabrication of replacement dock sections at Golden Manufacturing's Fort Myers production facility which has been certified by DQS Inc. to ISO 9001:2015. Utilizing premium marine-grade 6061-T6 aluminum, our Golden 850 Series Aluminum Dock sections were meticulously crafted to withstand the rigors of marine environments. Equipped with integrated Tracks, our docks offer versatility, allowing 12" cleats to slide fore and aft to accommodate individual vessels. The array at Snook Bight Marina features a 240' center walkway flanked by two 8' W x 725' L cross sections, each adorned with 11 - 4' W finger piers. For added convenience and safety, all docks are covered in fade- and slip-resistant Endeck® composite decking.

Nestled along the picturesque Estero Bay, Snook Bight Marina offers a full-service experience with 70 interior and linear slips, including a 160-boat dry-stack operation, rentals, sales and service. As a Suntex Boat Club member, you'll have access to award-winning waterfront restaurants and a host of amenities. For all your marina system needs, trust Golden Marine Systems®.

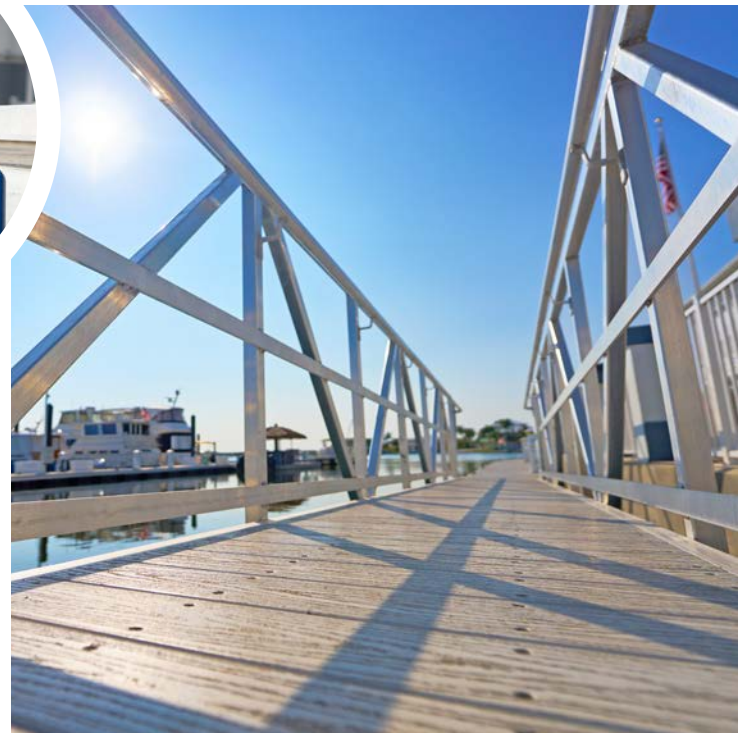



# MARINE MAX MARINAS

UNITING FORCES: GOLDEN MARINE  
SYSTEMS® & MARINE MAX LEAD THE  
WAY IN MARINE INNOVATION





Marine Max Clearwater



Golden Marine Systems® and MarineMax have forged a powerful collaboration built on shared values of innovation, quality, and customer satisfaction. Together, they have developed numerous marinas across the nation, combining Golden Marine Systems® expertise in designing and manufacturing world-class marine infrastructure with MarineMax's vast experience in boating and marine services. This collaboration has resulted in state-of-the-art marinas that offer unparalleled convenience, safety, and beauty to waterfront communities. By leveraging each other's strengths, Golden Marine Systems® and Marine Max have not only enhanced the boating experience for countless enthusiasts but also set new standards for excellence in marina development. Their joint efforts continue to transform waterfronts into thriving hubs of activity, providing lasting value to communities and ensuring a vibrant future for the marine industry.

Marine Max Sarasota

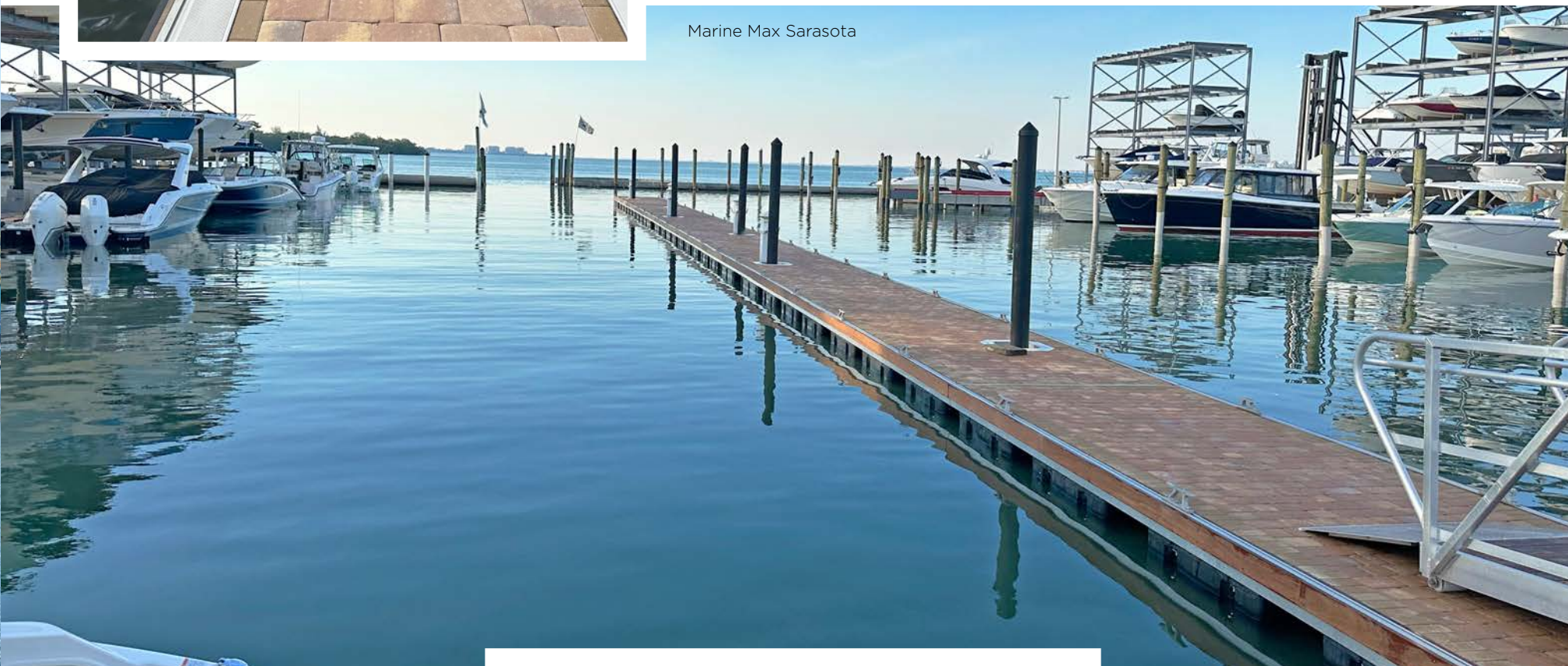

Marine Max Seaview



Marine Max Stuart



Marine Max Fort Myers



# IMPRESSIVE NEW DOCK PROJECT FOR MARINE MAX PENSACOLA

Golden Marine Systems®, a leading provider of innovative marine solutions based in Fort Myers, Florida, proudly announces the completion of the 'B' dock construction project for Marine Max Pensacola. Renowned for its exceptional specifications and seamless execution, the project underscores Golden Marine Systems'® commitment to excellence in marine infrastructure.

The newly constructed dock, extending an impressive 358 feet, boasts side-to-tie functionality and comprises 19 slips designed to accommodate vessels of up to 70 feet in length. Notably, the addition of a 100-foot fuel dock, featuring custom flotation tailored for a ship store, enhances the dock's versatility and utility for boaters.

Key components of the project include Golden Marine Systems'® state-of-the-art 850 Series single track system, renowned for its reliability and performance. Further enhancing durability and aesthetics, the dock features Endeck PVC decking, ensuring enduring resilience against the elements. Additionally, the incorporation of 12" GMS adjustable cleats ensures secure mooring, while pile guides and finger piers enhance functionality and safety for boaters.

GCG Construction, a reputable general contractor based in Fort Myers, Florida, played a pivotal role in overseeing execution, ensuring adherence to the highest standards of quality and craftsmanship. Furthermore, installation management was expertly handled by Mid-Coast Marine, guaranteeing meticulous attention to detail throughout the project lifecycle.

Mike Shanley, President of Golden Marine Systems®, expressed his gratitude for the seamless collaboration between Mid-Coast Marine and GCG Construction, citing their collective efforts as instrumental in the project's resounding success. "The completion of the 'B' dock project for Marine Max Pensacola exemplifies our unwavering commitment to delivering superior marine solutions," stated Shanley. "We are immensely proud of the craftsmanship and innovation showcased in this project, and we look forward to continuing to exceed the expectations of our clients."







# MARINE MAX MARINAS



# WHARF HOTEL AND MARINA

GOLDEN MARINE'S DOCK AT THE WHARF:  
A STAR-STUDDED ARRIVAL







Golden Marine Systems® has crafted a luxurious dock at The Wharf Hotel & Marina (now known as L'Escale Resort & Marina), offering guests a celebrity-style experience as they arrive by water. This glamorous dock is a testament to exquisite design and superior craftsmanship, featuring sleek, high-end materials and innovative features that provide both beauty and functionality. With its spacious layout and modern amenities, the dock accommodates vessels of all sizes, ensuring a smooth and elegant docking experience. This sophisticated addition enhances the allure of the hotel and marina, making it a premier destination for discerning travelers and boating enthusiasts seeking the finest in waterfront luxury. Whether you're mooring a yacht or simply enjoying the view, the dock at The Wharf provides an unparalleled level of comfort and style.

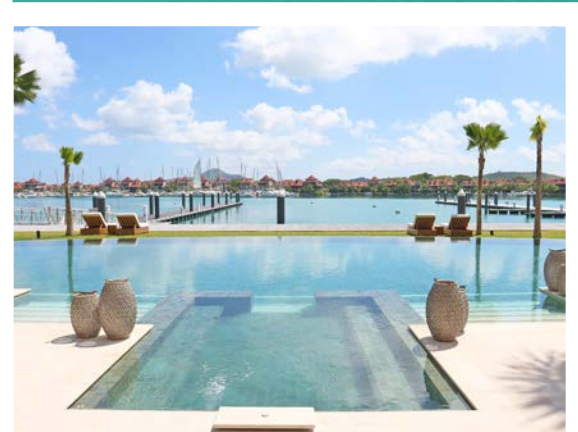
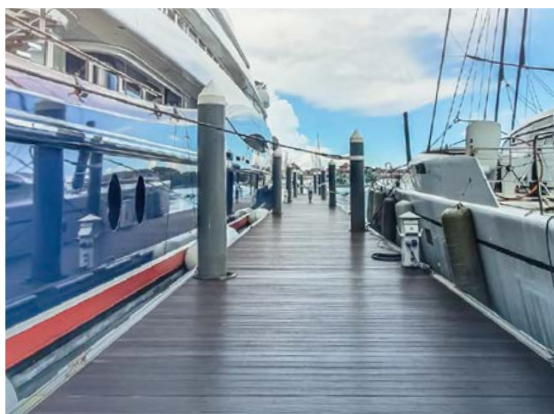
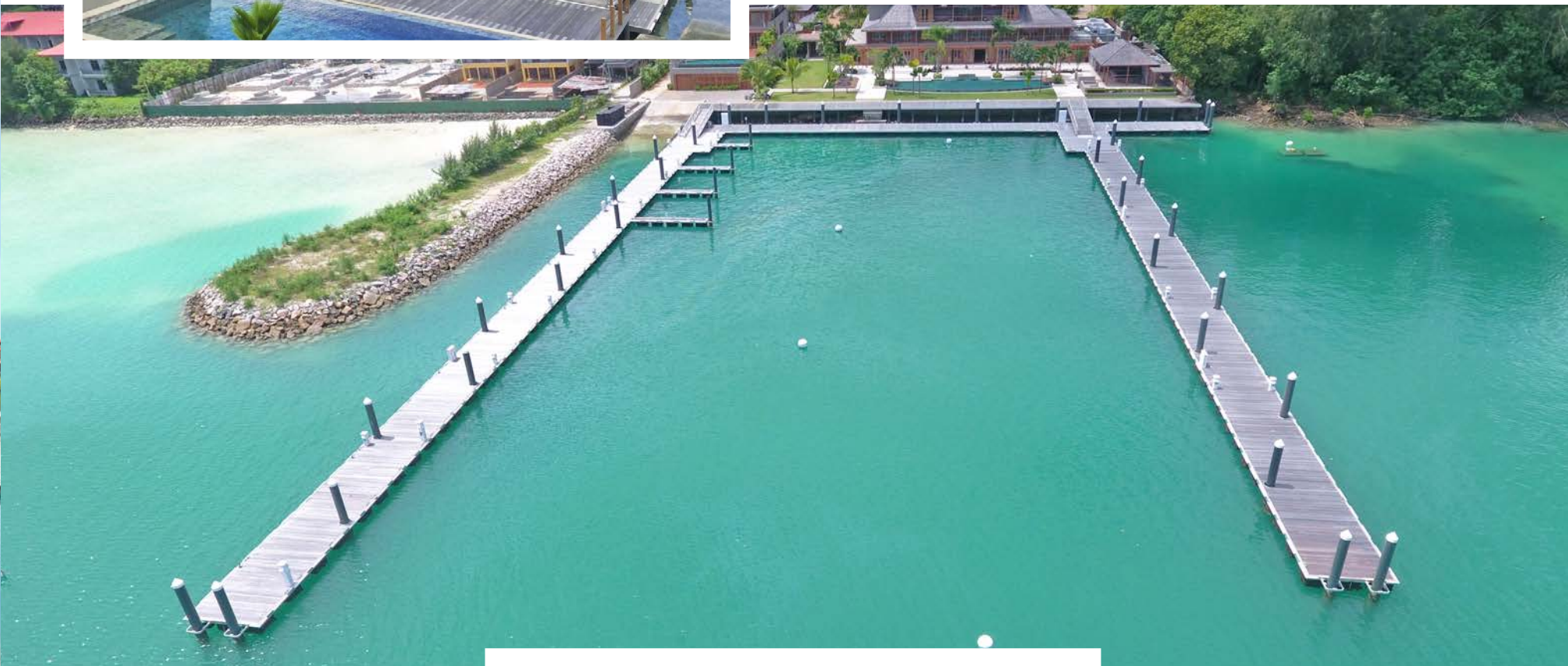



# STEELPOINTE MARINA

STEELPOINTE MARINA GETS  
THE GOLDEN TOUCH







Welcome to the pinnacle of waterfront excellence, where Golden Marine Systems® has redefined the standard of marina innovation at Steelpointe in Bridgeport, CT. Our transformative project showcases Golden's revolutionary Concrete Dock System, paired with stenciled pattern concrete decking, to offer unparalleled durability, aesthetics, and functionality.

Crafted with precision engineering and premium materials, Golden's Concrete Dock System at Steelpointe exemplifies our commitment to excellence. The stenciled pattern concrete decking not only enhances the beauty of the marina but also ensures enduring performance in the harsh marine environment.

Featuring adjustable cleats, pile guides, utility troughs, and gangways, our dock system is designed to streamline operations and enhance user experience for both boat owners and visitors alike. At Golden Marine Systems®, we believe in creating spaces that inspire and elevate, and Steelpointe is a testament to our vision.

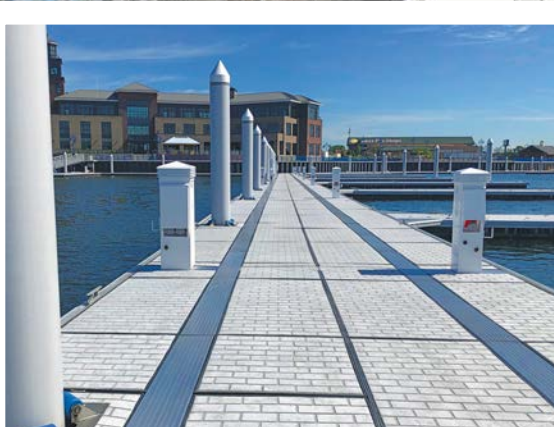



# TESTIMONIALS

## WORDS SHINE BRIGHTER THAN GOLD

Our company has proudly served as a Golden dealer for many years, primarily in the boat lift division. In recent years, we have expanded our partnership to include working with Golden Marine Systems® on large marina projects, utilizing their advanced floating dock systems.

Collaborating with Golden Marine Systems® has been a consistently positive experience. Their professional approach and commitment to open communication ensure that every project is meticulously designed and planned from start to finish. This level of thoroughness allows us to move forward with confidence, knowing that each detail has been thoughtfully considered.

Golden Marine Systems® products stand out for their robustness and ease of installation. The durability of their floating dock systems is unmatched, providing reliable performance even in challenging conditions. Moreover, the design simplicity of their systems significantly streamlines the installation process. Features such as pre-engineered utility channels make integrating additional components, like electrical and water utilities, remarkably straightforward, saving us time and effort.

We deeply appreciate our enduring relationship with the Golden companies. Their dedication to quality, innovation, and customer satisfaction aligns perfectly with our own values and standards. This synergy has not only enhanced our service offerings but has also reinforced our reputation for excellence in the industry.

Looking ahead, we are excited about the prospect of many more years of successful collaboration with Golden Marine Systems®. Together, we aim to continue delivering exceptional marina solutions that meet and exceed the expectations of our clients, ensuring their satisfaction and loyalty.

Jared Gorman  
Owner Gorman Marine



Duncan Seawall has worked with Golden Manufacturing for nearly 20 years. Our company purchases many aluminum floating docks from Golden each year.

We have found Golden to be dependable with the highest level of expertise. Golden staff are always timely in responding, professional, and accurate. We have always found that their manufacturing scheduling is always on time.

Duncan Seawall highly recommends Golden Manufacturing for both floating docks and boatlifts.

Steve Porter  
Duncan Seawall



We had the pleasure to work with Golden Marine Systems® on many private and municipal projects on the west coast of Florida. Golden Marine's superior product along with the level of expertise and experience gave us the comfort level that we were looking for in our dock manufacturer.

We were very satisfied with Golden Marine's attentiveness and ability to work with us on the specifications and detail required to successfully execute and develop our project.

All of the projects we worked on together were complete successes as the docks produced by Golden Marine are as promised, and delivered on time.

Golden Marine continues to follow up on our project annually with inspections and they are always available should we have any questions.

I would like to conclude by stating that I highly recommend Golden Marine's products and services.

Cynthia Belfatto  
Island Marine Group



Thank you very much for all of your support with our dock project. The docks themselves are well built and easy to assemble — we were able to get everything installed with the boys and the help of a few volunteers!

The whole experience, from ordering the docks to installation, vastly exceeded our expectations. Your high level of communication, follow up and commitment to the success of our project enabled us to progress smoothly through each phase of the process. The flexibility of Golden Marine and your attention to detail ensured that all the materials, and accompanying hardware, were delivered at the right time.

It has been a pleasure working with you and your team, and we look forward to a long and mutually rewarding relationship. I do, and will continue to recommend Golden Marine to anyone who asks about marine/dock projects.

Jim Filmont  
Safe Harbor Boys Academy

For more than five years, our partnership with Golden Marine Systems® has thrived, forging a strong alliance. Their procedures and products consistently impress with their intuitive design, streamlining operations seamlessly. Whether in commercial ventures or residential projects, from floating dock systems to boat lifts, our journey with them has been characterized by unwavering satisfaction. Golden's contribution is invaluable, demonstrated through meticulous collaboration in design, engineering, and value optimization. Their dedication to excellence aligns perfectly with our own ethos, creating a synergy that propels our projects with confidence. With enduring enthusiasm, we wholeheartedly endorse Golden Marine Systems and their Boatlifts, confident in their ability to consistently deliver excellence and reliability. Their track record speaks volumes, and we look forward to continuing our successful partnership for years to come.



Alex Shafer  
Traverse Group



# SERIES 950

## DOUBLE TRACK PROFILE

### CRAFTING THE FUTURE OF MARINE INFRASTRUCTURE

Golden Marine Systems® Series 950 double track profile is utilized for medium to mega yacht marinas and is recommended for vessel sizes up to 200'. The double-track system is durable and allows for adjustable cleats and bollards, pile guides and finger piers. The system can be manufactured to offer utility troughs that measures up to 4" high by 12" wide. A variety of decking options are available including brick pavers. The dock sections are connected with 70 durometer urethane blocks. The blocks are a noise free connection that allows the system to articulate in wind and wave conditions.











# SERIES 950

## DOUBLE TRACK PROFILE







## FEATURES

- For Medium Boat Marinas to Mega Yacht Marinas
- Double Track Extrusion
- Adjustable Cleats
- Pile Guides
- Finger Piers
- 3/16" Thick Webbed Extrusion
- All materials are of the highest grade marine alloys including 6061-T6 aluminum for the structures and 300 Series marine grade stainless steel for all connecting components.
- The design features of the floating docks allow for easy installation or future modifications.
- The ease of dock installation helps reduce construction cost by minimizing the man-hours required to install.
- Ability to add additional sections, finger piers, pile guides or accessories (pedestals, lighting, handrails, flag post, canopy posts) by utilizing custom made connection brackets.
- Cleats can be easily moved or replaced without the need to remove boards or thru-bolts.
- All floats are polyethylene with polystyrene EPS closed-cell foam. The floats are attached to the extrusion utilizing all marine-grade stainless steel bolts and locking nuts.
- Polyurethane rubber noise-free connectors for connecting dock sections are rated at 12,000 PSI. Each dock section has at least two connectors bringing the strength factor to a minimum of 24,000 PSI. The connectors are flexible and allow the dock system to articulate during storm or wave events. This prohibits the rigid binding of the dock system.
- Various decking is available including natural hardwoods, composite, aluminum pavers, and polyethylene decking panels - which allow light to seep through. All decking fits easily into the system allowing for easy replacement if damaged.
- Various fenders are available including natural hardwoods, composite, PVC, Vinyl, and HPDM rubbers.
- Utility access panels are available that allow easy access to all utilities both during installation and periodic maintenance needs.
- Various types of cleats are available that range in sizes from 10" to 20". The cleats are also marine grade cast aluminum which allows for durable strength and long life.
- All materials are manufactured in the U.S.A., Fort Myers, FL by aluminum fabricators certified by DQS Inc. to ISO 9001:2015 standards, policies, and procedures.



# SERIES 950

## DOUBLE TRACK PROFILE

### TYPICAL OVERVIEW

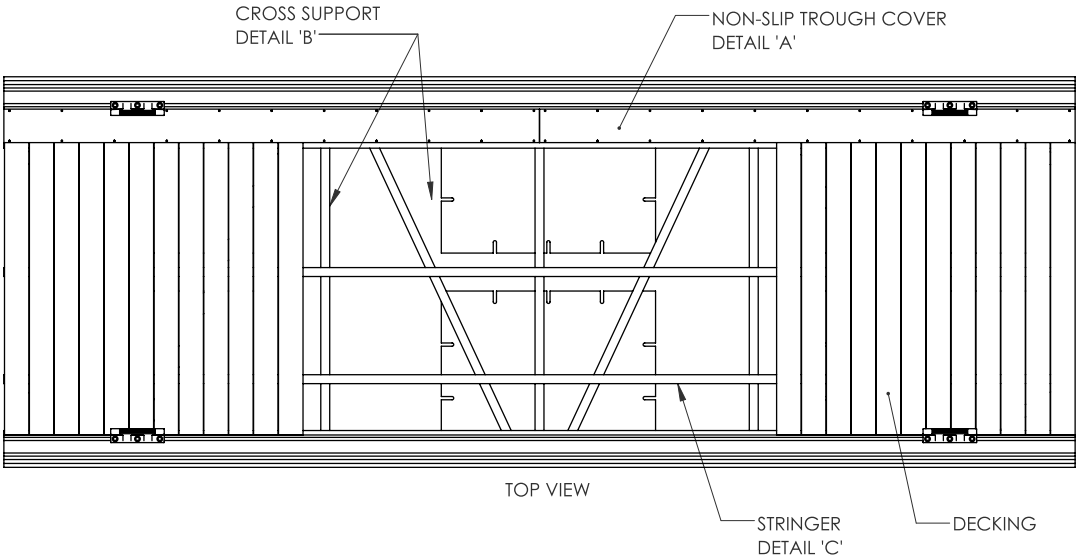

70 DUROMETER URETHANE BLOCK WITH INTEGRATED CHAIN

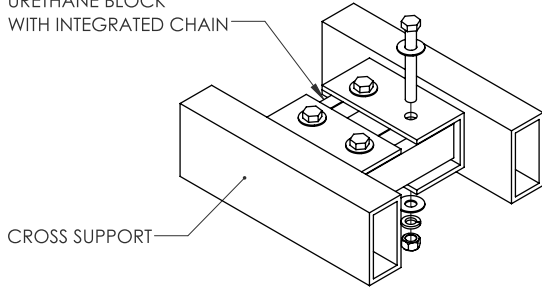

TYPICAL DOCK TO DOCK CONNECTION

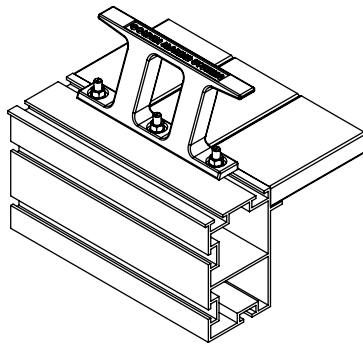
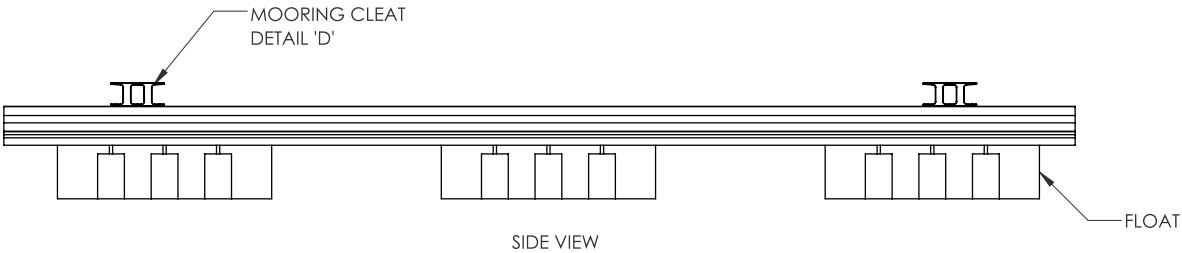

CLEAT ASSEMBLY DETAIL

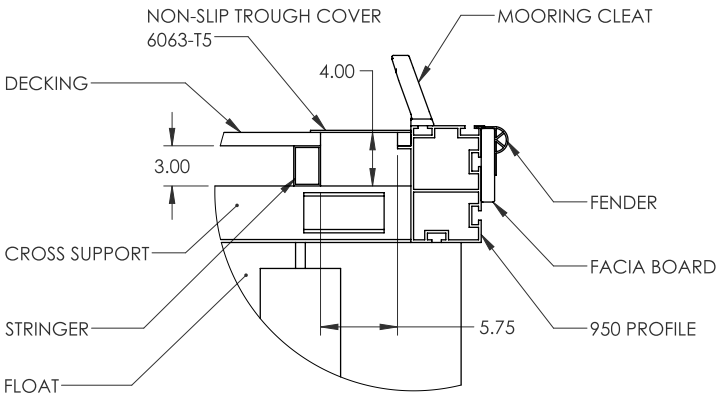
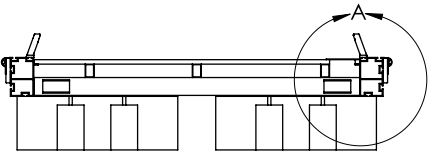

DETAIL A TYPICAL TROUGH

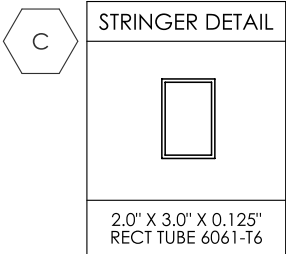
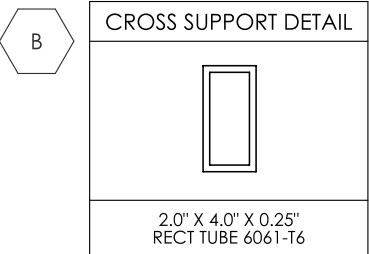
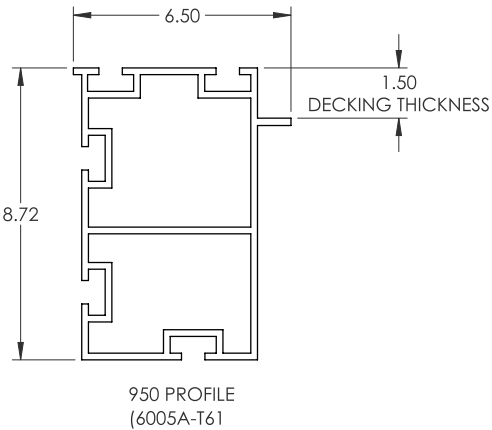

D

AVAILABLE CLEATS

AVAILABLE CLEATS	
CAST ALUMINUM	SIZES
	12" GMS
	16" GMS
	18" GMS
	20" GMS
	10" S-CLEAT
12" S-CLEAT	







# SERIES 850

## SINGLE TRACK PROFILE

### ENGINEERED FOR PERFORMANCE AND AESTHETIC APPEAL

Golden Marine Systems® Series 850 single track profile is utilized for light to large size marinas and is recommended for vessel sizes up to 80'. The single track system is durable and allows for adjustable cleats, pile guides and finger piers. The system can be manufactured to offer utility troughs that measure up to 4" high by 10" wide. The system decking is typically 5/4" board by 6". A variety of decking options are available including brick pavers. The dock sections are connected with 70 durometer urethane blocks. The blocks are a noise free connection that allows the system to articulate in wind and wave conditions.











# SERIES 850

## SINGLE TRACK PROFILE







## FEATURES

- For Small Boat Marinas to Large Boat Marinas
- Single Track Extrusion
- Adjustable Cleats
- Pile Guides
- Finger Piers
- 3/16" Thick Webbed Extrusion
- All materials are of the highest grade marine alloys including 6061-T6 aluminum for the structures and 300 Series marine grade stainless steel for all connecting components.
- The design features of the floating docks allow for easy installation or future modifications.
- The ease of dock installation helps reduce construction cost by minimizing the man-hours required to install.
- Ability to add additional sections, finger piers, pile guides or accessories (pedestals, lighting, handrails, flag post, canopy posts) by utilizing custom made connection brackets.
- Cleats can be easily moved or replaced without the need to remove boards or thru-bolts.
- All floats are polyethylene with polystyrene EPS closed-cell foam. The floats are attached to the extrusion utilizing all marine-grade stainless steel bolts and locking nuts.
- Polyurethane rubber noise-free connectors for connecting dock sections are rated at 12,000 PSI. Each dock section has at least two connectors bringing the strength factor to a minimum of 24,000 PSI. The connectors are flexible and allow the dock system to articulate during storm or wave events. This prohibits the rigid binding of the dock system.
- Various decking is available including natural hardwoods, composite, aluminum pavers, and polyethylene decking panels - which allow light to seep through. All decking fits easily into the system allowing for easy replacement if damaged.
- Various fenders are available including natural hardwoods, composite, PVC, Vinyl, and HPDM rubbers.
- Utility access panels are available that allow easy access to all utilities both during installation and periodic maintenance needs.
- Various types of cleats are available that range in sizes from 10" to 20". The cleats are also marine grade cast aluminum which allows for durable strength and long life.
- All materials are manufactured in the U.S.A., Fort Myers, FL by aluminum fabricators certified by DQS Inc. to ISO 9001:2015 standards, policies, and procedures.



# SERIES 850

## SINGLE TRACK PROFILE

### TYPICAL OVERVIEW

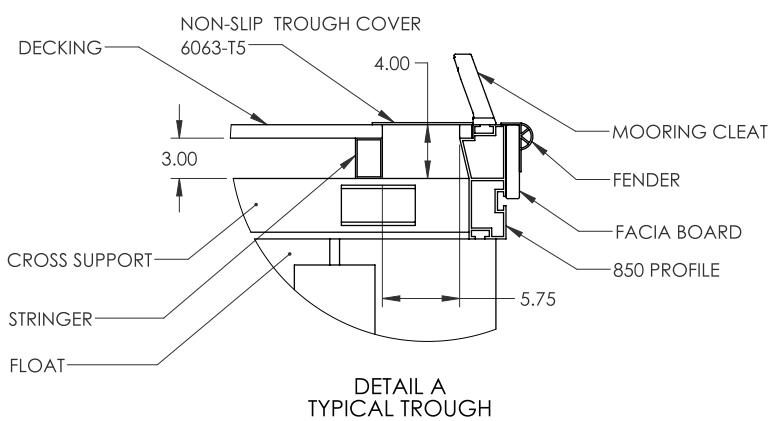
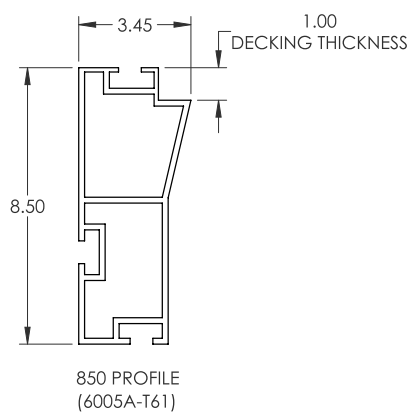
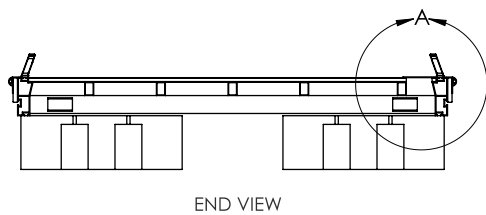
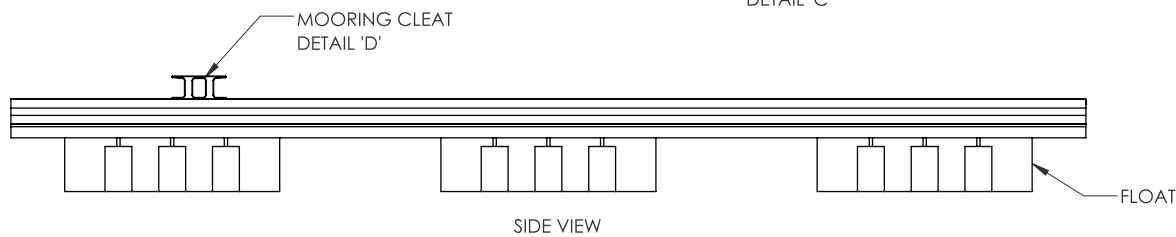
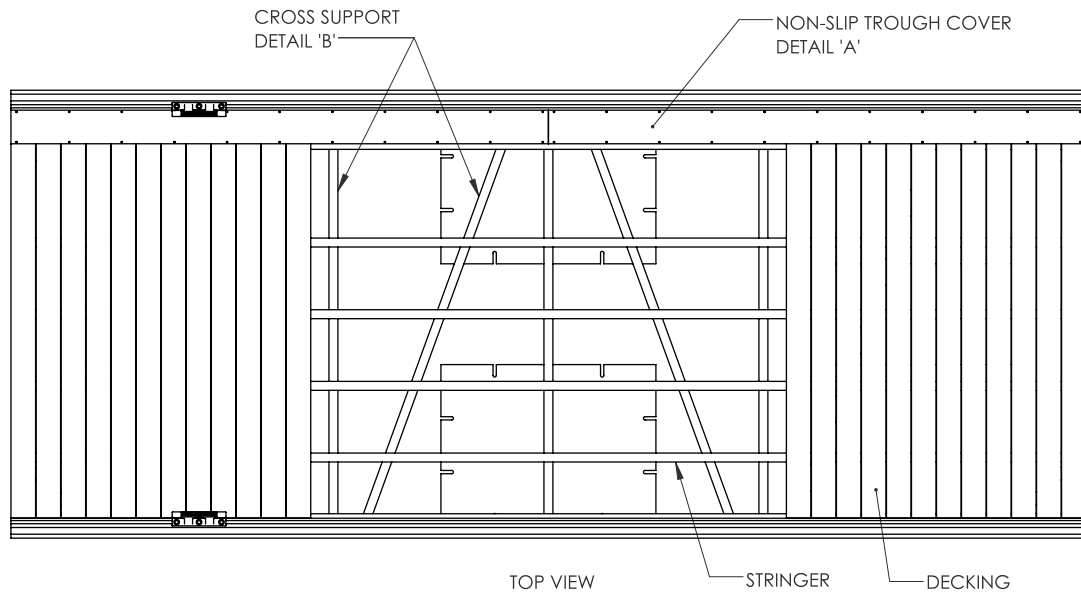

70 DUROMETER URETHANE BLOCK WITH INTEGRATED CHAIN

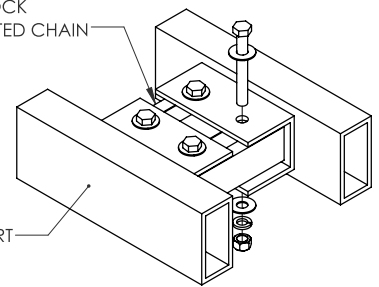

TYPICAL DOCK TO DOCK CONNECTION

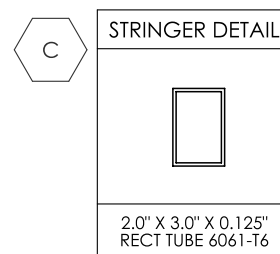
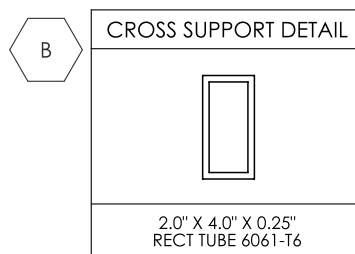
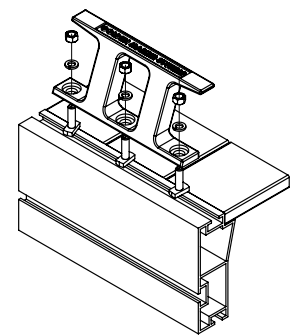

D

AVAILABLE CLEATS

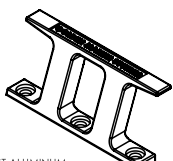
CAST ALUMINUM	SIZES	
		12" GMS
	16" GMS	
	18" GMS	
	20" GMS	
	10" S-CLEAT	
	12" S-CLEAT	







# SERIES 9

## WHERE ENGINEERING EXCELLENCE MEETS STYLISH FUNCTIONALITY

Golden Marine Systems® Series 9 profile is utilized for light duty marinas and is recommended for vessels up to 40'. The system utilizes 6061-T6 channel extrusion and 300 series stainless steel hardware. The system can be manufactured to offer service troughs to accommodate the most common utility needs. The system decking is typically 5/4" x 6" board. A variety of decking options are available including brick pavers. The dock sections are connected with 70 durometer urethane blocks. The blocks are a noise free connection that allows the docks to articulate in wind and wave conditions.











# SERIES 9







## FEATURES

- For Residential or Small Boat Marinas
- All materials are of the highest grade marine alloys including 6061-T6 aluminum for the structures and 300 Series marine grade stainless steel for all connecting components.
- The design features of the floating docks allow for easy installation or future modifications.
- The ease of dock installation helps reduce construction cost by minimizing the man-hours required to install.
- Ability to add additional sections, finger piers, pile guides or accessories (pedestals, lighting, handrails, flag post, canopy posts) by utilizing custom made connection brackets.
- All floats are polyethylene with polystyrene EPS closed-cell foam. The floats are attached to the extrusion utilizing all marine-grade stainless steel bolts and locking nuts.
- Polyurethane rubber noise-free connectors for connecting dock sections are rated at 12,000 PSI. Each dock section has at least two connectors bringing the strength factor to a minimum of 24,000 PSI. The connectors are flexible and allow the dock system to articulate during storm or wave events. This prohibits the rigid binding of the dock system.
- Various decking is available including natural hardwoods, composite, aluminum pavers, and polyethylene decking panels - which allow light to seep through. All decking fits easily into the system allowing for easy replacement if damaged.
- Various fenders are available including natural hardwoods, composite, PVC, Vinyl, and HPDM rubbers.
- Utility access panels are available that allow easy access to all utilities both during installation and periodic maintenance needs.
- Various types of cleats are available that range in sizes from 10" to 20". The cleats are also marine grade cast aluminum which allows for durable strength and long life.
- All materials are manufactured in the U.S.A., Fort Myers, FL by aluminum fabricators certified by DQS Inc. to ISO 9001:2015 standards, policies, and procedures.



# SERIES 9

## TYPICAL OVERVIEW

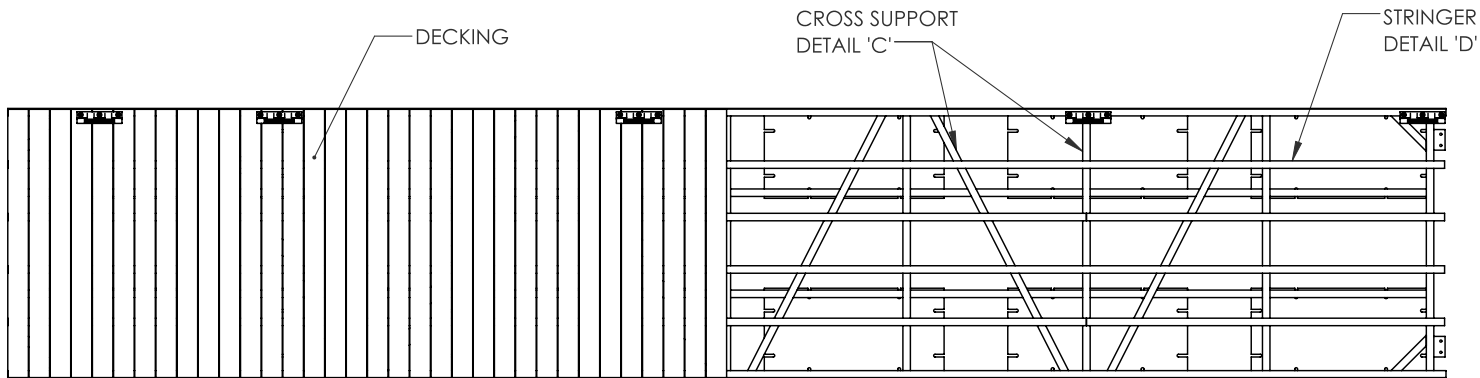

TOP VIEW

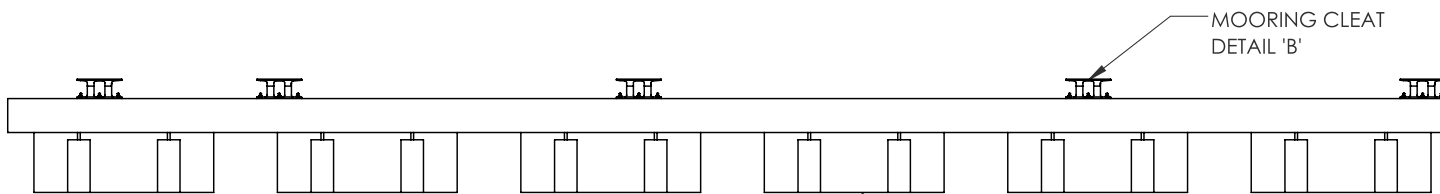

SIDE VIEW

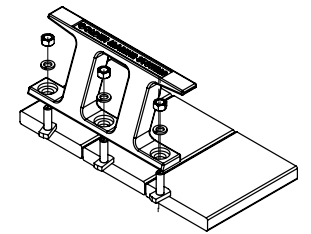

CLEAT ASSEMBLY DETAIL

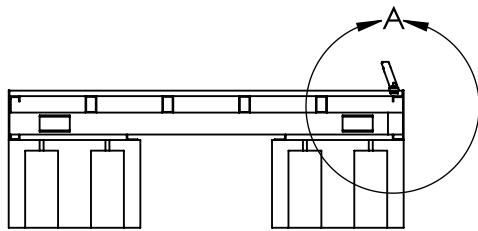

END VIEW

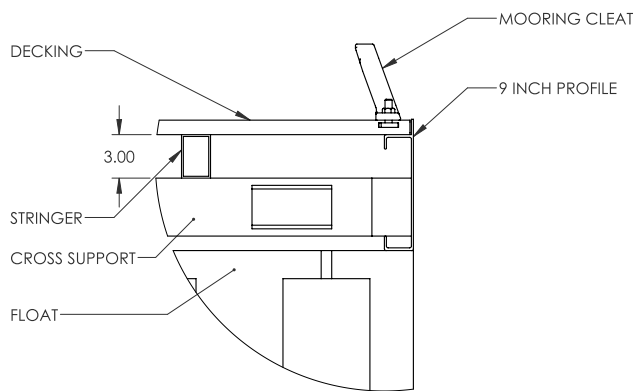

DETAIL A

70 DUROMETER URETHANE BLOCK WITH INTEGRATED CHAIN

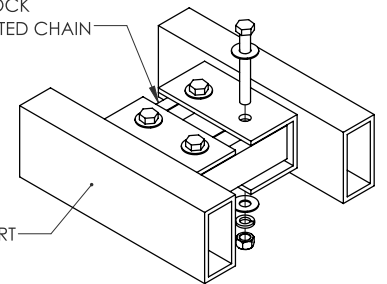

TYPICAL DOCK TO DOCK CONNECTION

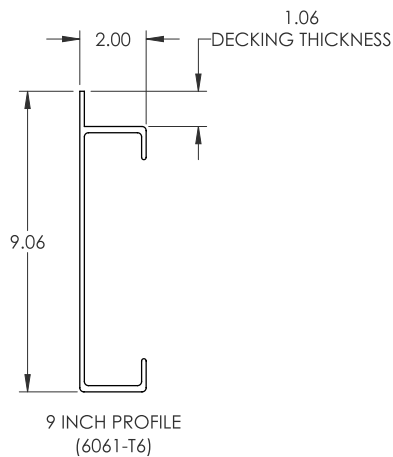

9 INCH PROFILE (6061-T6)



AVAILABLE CLEATS	
<p>CAST ALUMINUM</p>	SIZES
	12" GMS
	16" GMS
	18" GMS
	20" GMS
	10' S-CLEAT
12' S-CLEAT	



CROSS SUPPORT DETAIL
2.0" X 3.0" X 0.25" RECT TUBE 6061-T6



STRINGER DETAIL
2.0" X 3.0" X 0.125" RECT TUBE 6061-T6







# DOCK STABILIZER

## THE GAME-CHANGER

The patented Golden Dock Stabilizer was designed to eliminate wobbly and unstable floating docks. Floating docks that are too narrow, aging, or incorrectly designed can sometimes be unsafe and unstable. The Dock Stabilizer has been proven, once installed, to stabilize and level a floating dock greatly. Results on our first installation were way beyond our and our client's expectations. The Golden Dock Stabilizer is a game-changer and another innovative idea and product designed, patented, and manufactured by Golden.



### Dock Stabilizer Highlights:

- Stabilizes floating docks and wave attenuators
- Minimizes heaving and tilting from wave action
- Pile diameter is not limited
- Multi-level pile guide with rollers spaced at dock level
- Adjustable to assist in leveling the dock





# GOLDEN BOAT LIFTS® WINS INNOVATION AWARD FOR DOCK STABILIZER

Golden won an Innovation Award for its Golden Dock Stabilizer, presented by the National Marine Manufacturers Association and Boating Writers International (BWI) at the 2020 Progressive Insurance Miami International Boat Show. The product stabilizes wobbly floating docks and minimizes heaving, movement and lifting due to wind and wave action. It won in the Docking & Fendering Equipment category.

Selected by a panel of seven BWI judges, the Golden Dock Stabilizer was recognized as an exceptionally groundbreaking marine product. Ed Sherman, award judge, said it's "a wonderful solution to the age-old problem of a wobbly dock." Unlike traditional pile hoops, the Golden solution only moves vertically. Because tolerances are tighter between the device and piling, the system provides greater rigidity over the run of the dock.

Made in the USA and built to ISO 9001:2015 standards, the frame and protective cowling of the Golden Dock Stabilizer are made from welded 6061-T6 marine-grade aluminum. Assembled with 300-series stainless steel hardware, the rollers are UHMW polyethylene and placed at multiple levels within the device. It's designed to accommodate any pile diameter and each can be adjusted to assist in leveling the dock.

"We're pleased to be honored with this award," said Bill Golden, president and CEO of Golden Boat Lifts and Marine Systems. "This is a serious game-changer for any floating dock, whether it's private or public, recreational or commercial." The Golden Dock Stabilizer works equally well with wave attenuators.

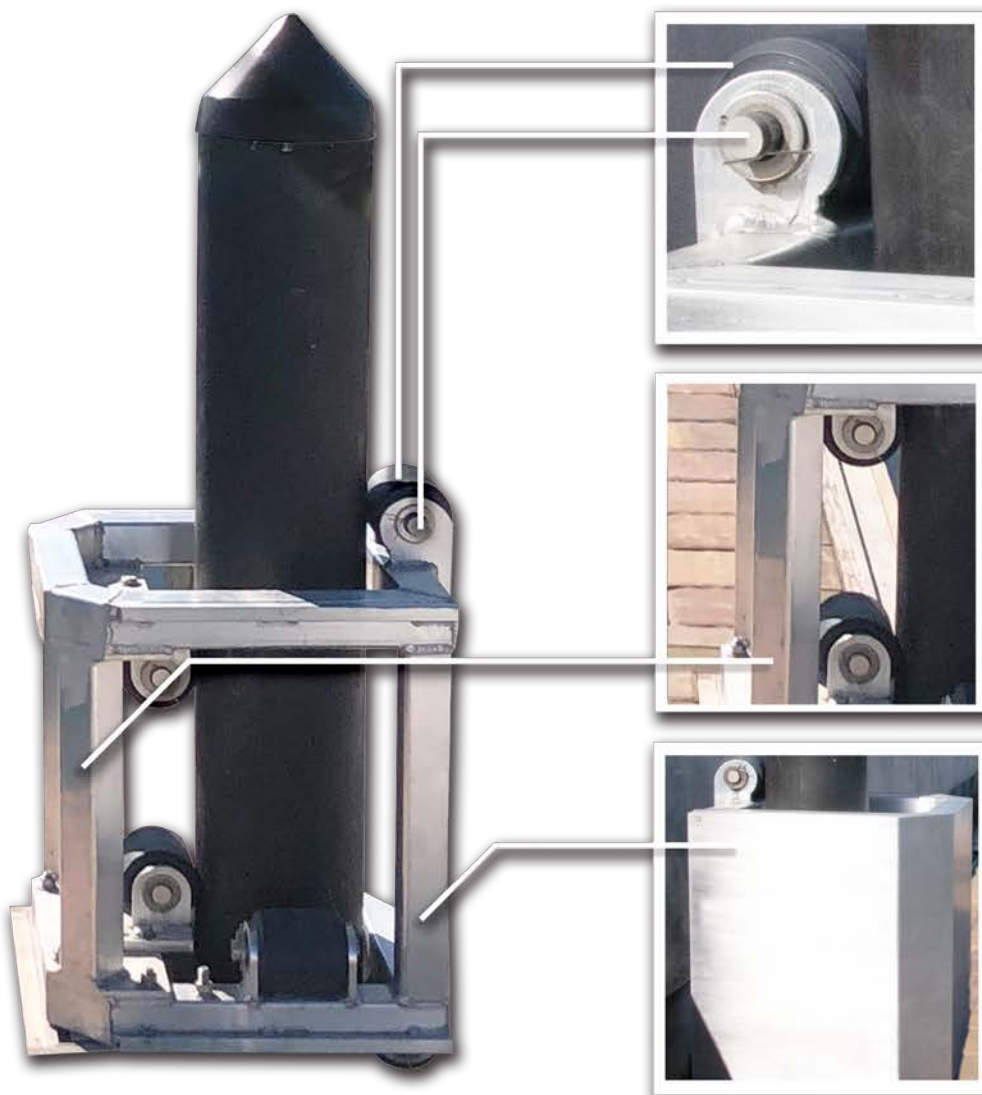

UHMW Rollers

Assembled with  
300 Series  
Stainless Steel  
Hardware

Frame  
Constructed  
Using  
6061-T6  
Aluminum

Protective  
Cowling  
Constructed with  
6061-T6  
Aluminum





# GANGWAYS

STYLISH AND STURDY: EXPLORE OUR SUPERIOR GANGWAYS FOR SMOOTH ACCESS







We offer various types of decking from aluminum, composite, natural hardwood and polypro grated decking to mention a few. Our gangways are designed to be maintenance free, strong, versatile and safe. We offer both residential and commercial rated gangways that are ADA compliant and can be manufactured for golf cart accessibility.



#### Gangway Highlights:

- 6061-T6 Marine Grade Aluminum and 300 Series Stainless Steel
- Various types of decking
- Diamond plate transition plates
- Heavy-duty mounting plate
- Nylatron Roller assembly
- ADA compliant



# GOLDEN SUNSHADE™

SHIELD YOUR VESSEL IN STYLE







Introducing the Golden Sunshade™, the premier canopy cover designed to offer unparalleled protection and sleek style for your boat lift. Crafted with high-quality, weather-resistant materials, the Golden Sunshade™ ensures your vessel remains shielded from the elements, extending its lifespan and maintaining its pristine condition. Its innovative design combines functionality with elegance, featuring an adjustable frame that provides a custom fit for various boat sizes. Easy to install and maintain, the Golden Sunshade™ enhances your docking experience by keeping your boat cool and protected while adding a touch of sophistication to your marina. Experience the perfect blend of form and function with the Golden Sunshade™, and keep your boat looking and performing its best year-round.





# TIKI MUNDO

## PALMEX USA

### BEAUTY THAT WEATHERS THE STORM



- Quick and easy to installation for DIYers and professionals.
- 20-year warranty
- 50-year lifespan
- Non-toxic and 100% recyclable
- Unlike natural thatch, Palmex will not attract pests, rot, mold, or mildew
- Wind rated to 160 mph
- Fire retardant products available
- When compared to natural thatch Palmex will provide return on investment in as little as 3 years





Palmex is the current world leader in the production and distribution of premium, eco-friendly synthetic palm leaves used in construction and in the renovation of traditional thatch roofing. We offer unparalleled customer support, guiding you from initial concept to lasting roof excellence. Our versatile roofing solutions are perfect for:

- Hotels and Resorts
- Theme Parks
- Zoos
- Housing
- Retreat/Centers
- Waterparks
- Beaches
- Camping/RV facilities
- Bars and restaurants
- Backyard DIYers



Follow us on social media



Interested in creating your own tiki space for your home or business? Scan the QR code to download your free copy of "The Ultimate Buyers Guide to Synthetic Thatch Roofing"

ebook



Facebook



Instagram

Call us today for a free consultation 833-998-0823



# WHEN IT'S DONE RI





# IGHT, IT'S GOLDEN





# GOLDEN<sup>®</sup>

BOAT LIFTS & MARINE SYSTEMS

239.337.4141  
sales@GoldenBoatLifts.com  
www.GoldenBoatLifts.com  
www.GoldenMarineSystems.com

